

5770 N 11.96 E

Tech & Soul

Scandi-design **eyewear**. Driven
by environment & curiosity

tripoint

AW24/25

GLASSES WITH A MISSION

We want to make accessible innovative sports glasses that respect the environment and protect your eyes throughout every moment of your life.



Design

We love fashion, we love simple, we love innovative design.

We also love fair prices. So that cycling, skiing and traveling while being well protected remain moments that we can all enjoy.

Curiosity

In 50 years, we want to be able to look back on the sports glasses industry and laugh. Knowing things have changed, and we have played a major role in the transformation.

Environment

Whether it's about choosing our materials or selecting our partners, our glasses are manufactured according to a very strict set of specifications to ensure our products are safe and long-lasting.

Ever since we were kids, we have taken the environment for granted. But then we grew up and realized that nothing will last forever. That is why we have a sustainability mindset in everything we do.





tripoint.com

THE BEGINNING

Embark on a journey with Tripoint, where passion for design and an unwavering commitment to empowering athletes converg.



Our journey began with a shared passion for design and an unwavering commitment to empower athletes in reaching their pinnacle of success. As a group of visionaries, we set out to merge style with substance, creating sports glasses that not only elevate your performance but also embody the essence of cutting-edge design.

Driven by the belief that athletes deserve more than just gear – they deserve an experience – we embarked on a mission to craft products that seamlessly blend functionality with flair. Our love for sports and the athletes who fuel our inspiration motivates us to push the boundaries of innovation, ensuring every pair of Tripoint sports glasses is a testament to our dedication.

But it's not just about the glasses; it's about the athletes who wear them. We're here to be more than just a brand; we're their dedicated partners in the pursuit of greatness. Our commitment extends beyond delivering top-notch products to providing an unparalleled level of service. Your goals are our goals, and together, we strive to conquer new heights.





SVENSKA
SPEL



tripoint.com

WHAT DOES TRIPOINT STAND FOR?



The name Tripoint is a geographical point at which the boundaries of three countries or subnational entities meet. This creates a unique place and binds countries together.

Tripoints can be found all over the world. There are approximately 176 international tripoints. We are humble and respectful to these surroundings. Knowing they can hit us with full force. That is why we adapt, that is why we prepare, that is why Tripoint exists. Made to withstand the harsh and variable climate and ready to take on every challenge.





tripoint

TRI-X VISION
Lens boost technology

When the surroundings and the weather conditions are harsh and unpredictable. Or you want a lens that is perfectly adapted to your purpose. The Tri-X Vision lens technologies are here to help.

TRI-X | Polarized

The Tri-x polarized lens cuts out all reflecting light rays. No more glare from water, snow, wet roads or other reflecting materials.

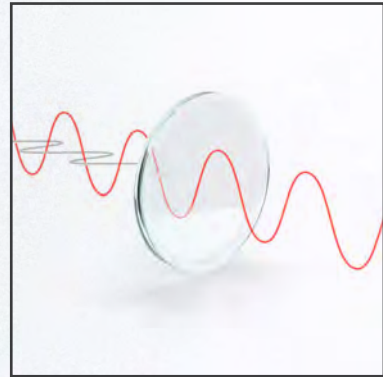

TRI-X | UltraVue

The Tri-x contrast lens are made to boost colors and contrast in low light conditions. The lens blocks all the fuzzy colors in the color spectra. This results in a sharp, clear vision even in low light.

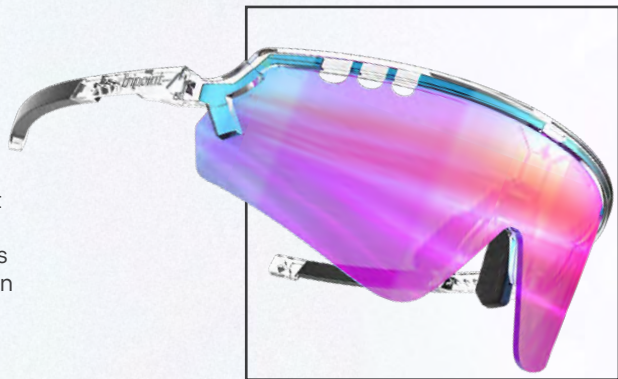

TRI-X | Chromic

The Tri-x chromic lens are made to suit every weather condition. The lens changes its shading automatically and instantly from light to dark and back again based on the weather condition.

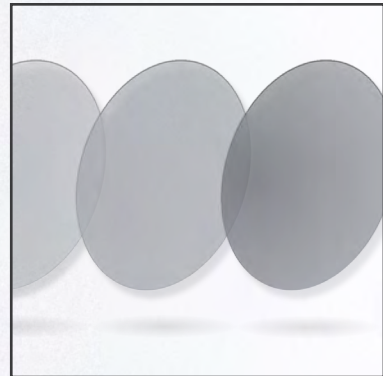

BI^o-BASED | Nylon lens

The Tri-x nylon lens offer the pleasure of a crisp clear vision. The comfort of ultralight weight. Safety in form of durability and shatter resistance.

Nylon as material are Bio-based and free from harmful BPA chemicals.



TRI-X | Polarized

At sea	● ● ● ● ●	5
On the road	● ● ● ● ●	5
Fishing	● ● ● ● ●	5
Glacier	● ● ● ● ●	5

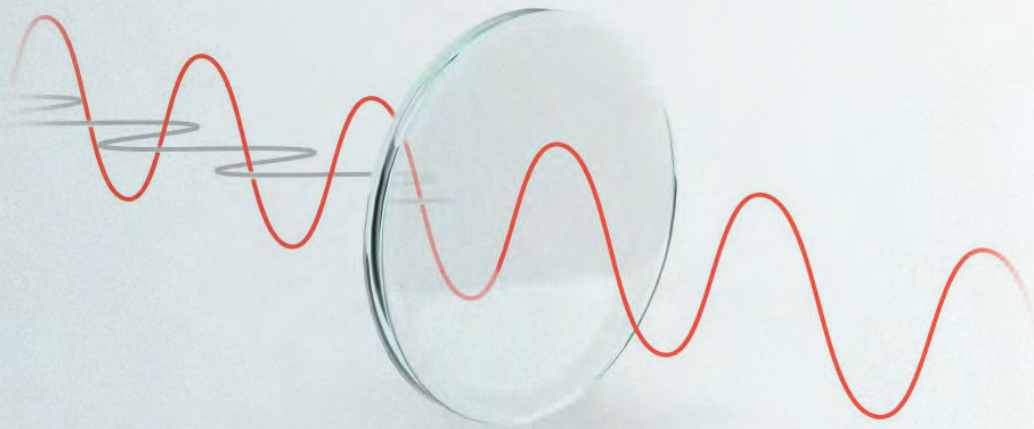

| Polarized

Tired of being blinded by harsh glare when you're out and about? It's time to see the world in all its glory without the annoying distractions. Say hello to the Tri-x Polarized Lens – the ultimate solution to eliminate reflections and enhance your visual experience!

Glare-Free Clarity:

Tri-x Polarized lenses are meticulously crafted to cut out all those pesky reflecting light rays. Whether it's blinding sunbeams on water, glistening snow, or slick, wet roads, our lenses ensure you see clearly without any distracting glare.

Uninterrupted Water Adventures:

Love spending time by the water but hate the glare bouncing off the surface? Tri-x Polarized is your perfect companion for fishing, boating, or simply soaking up the sun by the beach. Dive into crystal-clear vision, and don't let glare spoil your aquatic fun!

Safely Navigate Snowy Slopes:

Skiing or snowboarding on bright, sunny days?

Tri-x Polarized keeps your vision sharp without those blinding reflections on the slopes. Enjoy your winter adventures without squinting in the snow.

Safer Road Trips:

Road trips are a breeze with Tri-x Polarized. Say goodbye to the blinding headlights of oncoming cars and the shimmering glare on wet roads. Drive safely and comfortably, day or night.

True Colors Shine Through:

Our lenses not only eliminate glare but also reveal the true beauty of your surroundings. Experience vibrant colors, enhanced contrast, and a world filled with stunning detail.

Rediscover the world in all its glory with Tri-x Polarized. Don't let annoying reflections hinder your experiences – choose the lens that lets you see the world on your terms. Tri-x Polarized – where clarity meets style, and glare becomes a thing of the past!

001 Treriksröset Tri-x Polarized



TRIS001-009
Frame: Shiny transparent black
Lens: Polarized brown/silver mirror. Cat 3



TRIS001-010
Frame: Shiny crystal
Lens: Polarized brown/silver mirror. Cat 3

003 Reschen Tri-x Polarized



TRIS003-110
Frame: Shiny transparent black
Lens: Polarized brown/silver mirror. Cat 3



TRIS003-111
Frame: Shiny crystal
Lens: Polarized brown/silver mirror. Cat 3

007 Chobe Tri-x Polarized



TS0007S001
Frame: Shiny transparent black
Lens: Polarized brown/silver mirror. Cat 3



TS0007S002
Frame: Shiny crystal
Lens: Polarized brown/silver mirror. Cat 3

TRI-X | Chromic

Indoor & night	● ● ● ● ●	5
Cloudy days	● ● ● ● ●	5
Bright & sunny days	● ● ● ● ●	5



| Chromic

Are you tired of constantly switching between different lenses to match ever-changing weather conditions? Say hello to the future of eyewear with Tri-x Chromic – the lens that adapts instantly to your surroundings!

Seamless Adaptation:

Tri-x Chromic lenses are the perfect solution for unpredictable weather. They effortlessly transition from light to dark and back again, ensuring optimal visibility in any condition. No more squinting in bright sunlight or straining your eyes on cloudy days.

All-Weather Performance:

Whether you're hitting the slopes on a sunny day or braving a sudden rainstorm, Tri-x Chromic has you covered. Say goodbye to the hassle of swapping lenses – enjoy your outdoor activities without interruption.

Uncompromised Clarity:

Our advanced technology doesn't just adapt to changing light; it enhances your vision. With

Tri-x Chromic, you'll experience vivid colors and sharp details, no matter what Mother Nature throws your way.

Stylish and Functional:

Tri-x Chromic lenses aren't just about performance; they're a style statement too. These sleek, modern lenses complement any frame, allowing you to look great while seeing clearly.

Instant Transition:

The magic of Tri-x Chromic happens in the blink of an eye. Experience a lens that responds instantly to light conditions, providing you with the perfect shade when you need it most.

Be prepared for every moment with Tri-x Chromic and enjoy a seamless, adaptable visual experience like never before. Don't let changing weather dampen your day – embrace the future of eyewear with Tri-x Chromic! Your vision, your style, your comfort – all in one remarkable lens.

001 Treriksroset Tri-x Chromic



TRIS001-007
Frame: Shiny transparent black
Lens: Photochromic smoke/blue multi. Cat 0-3

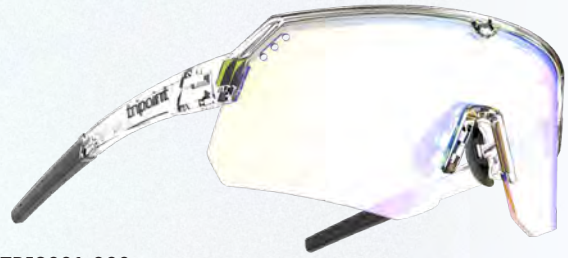

TRIS001-008
Frame: Shiny crystal
Lens: Photochromic smoke/blue multi. Cat 0-3

003 Reschen Tri-x Chromic



TRIS003-108
Frame: Shiny transparent black
Lens: Photochromic smoke/blue multi. Cat 0-3



TRIS003-109
Frame: Shiny crystal
Lens: Photochromic smoke/blue multi. Cat 0-3

007 Chobe Tri-x Chromic



TS0007S003
Frame: Shiny transparent black
Lens: Photochromic smoke/blue multi. Cat 0-3

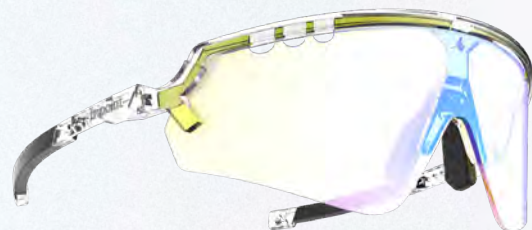

TS0007S004
Frame: Shiny crystal
Lens: Photochromic smoke/blue multi. Cat 0-3

TRI-X | UltraVue

Contrast enhancer ● ● ● ● ● 5

Low light conditions ● ● ● ● ● 5



| UltraVue

Are you tired of dull, fuzzy visuals in low-light conditions while enjoying your favorite activities? Say goodbye to those frustrating moments, because Tri-x UltraVue is here to revolutionize your experience!

Enhanced Color and Contrast:

Tri-x UltraVue lenses are expertly designed to intensify colors and contrast in low-light settings. No more struggling to distinguish details or battling the blur of fuzzy colors – our lenses cut through the haze for a vibrant, crisp view!

Optimal Clarity in Low Light:

Whether you're hitting the slopes at dusk, venturing out for an evening hike, or simply navigating dimly lit environments, Tri-x UltraVue ensures you see with precision. Our advanced technology lets you enjoy every moment with unparalleled clarity.

Versatile Performance:

Tri-x UltraVue lenses aren't just for one activity; they're your all-in-one solution for any low-light situation. From skiing and snowboarding to nighttime strolls and indoor events, you can trust Tri-x to enhance your vision every time.

See the World in True Colors:

Experience the world as it's meant to be seen – vibrant, sharp, and full of detail. Tri-x UltraVue lenses block out the noise of fuzzy colors, revealing the true beauty around you, even when the sun has set.

Become one with your vision and seize every moment, no matter the lighting conditions. Discover the Tri-x UltraVue difference today and elevate your visual experience to new heights! Don't settle for less when you can have the best.

001 Treriksroset

Tri-x UltraVue



TRIS001-001
Frame: Shiny transparent black
Lens: Orange/blue multi. Cat 1



TRIS001-003
Frame: Shiny transparent black
Lens: Violet/blue multi. Cat 2



TRIS001-002
Frame: Shiny crystal
Lens: Orange/blue multi. Cat 1



TRIS001-004
Frame: Shiny crystal
Lens: Violet/blue multi. Cat 2

003 Reschen

Tri-x UltraVue



TRIS003-101
Frame: Shiny transparent black
Lens: Orange/blue multi. Cat 1



TRIS003-103
Frame: Shiny transparent black
Lens: Violet/blue multi. Cat 2



TRIS003-102
Frame: Shiny crystal
Lens: Orange/blue multi. Cat 1



TRIS003-104
Frame: Shiny crystal
Lens: Violet/blue multi. Cat 2

007 Chobe

Tri-x UltraVue



TS0007S005
Frame: Shiny transparent black
Lens: Orange/blue multi. Cat 1



TS0007S007
Frame: Shiny transparent black
Lens: Violet/blue multi. Cat 2



TS0007S006
Frame: Shiny crystal
Lens: Orange/blue multi. Cat 1



TS0007S008
Frame: Shiny crystal
Lens: Violet/blue multi. Cat 2

BIO-BASED | Nylon lens

Extreme clarity	● ● ● ● ●	5
Sustainable	● ● ● ● ●	5
Ultralight	● ● ● ● ●	5
BPA-free	● ● ● ● ●	5



| Nylon lens

Unobstructed vision with biobased nylon lenses

For maximal safety and top performance it is important that your glasses do not obstruct your vision and only enhance it. Tripoint comes with a biobased Nylon lens with extremely high optical quality. The Nylon lens is both lighter and provides a clearer view than Polycarbonate, which is the most common material for lenses in sports glasses. The lens is also flexible, resistant and has a good "memory". If you bump or bend them, they will return to their original shape. Nylon as a material is also free from BPA, which is a chemically harmful substance for the body. Not only does the lens provide better performance, but it also has less impact on the environment in the manufacturing process.

Tripoint also offers an endless amount of interchangeable lenses to maximize vision in the widest variety of different weather conditions. Tripoint complies with standards EN ISO 12312-1, AS/NZS 1067 & ANSI Z80.3.

Light weight biobased nylon frame

The biobased frame is made of a strong lightweight Nylon material and puts minimal strain on the nose, ears and environment thanks to the low weight and biobased material. To ensure maximum mobility for the head and minimum tension in the neck, Tripoint sports glasses are superlight, they often weight less than 40g.

| 001 Treriksroset
Biobased Nylon lens

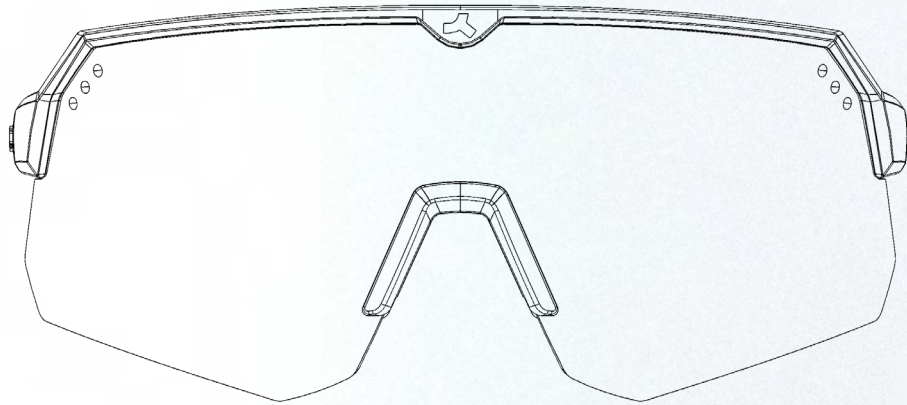

| 002 Jongsong Peak
Biobased Nylon lens

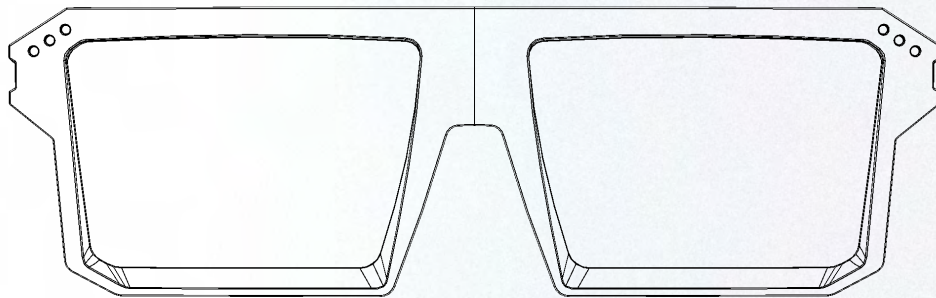

| 002 Jongsong Peak
Biobased Nylon lens

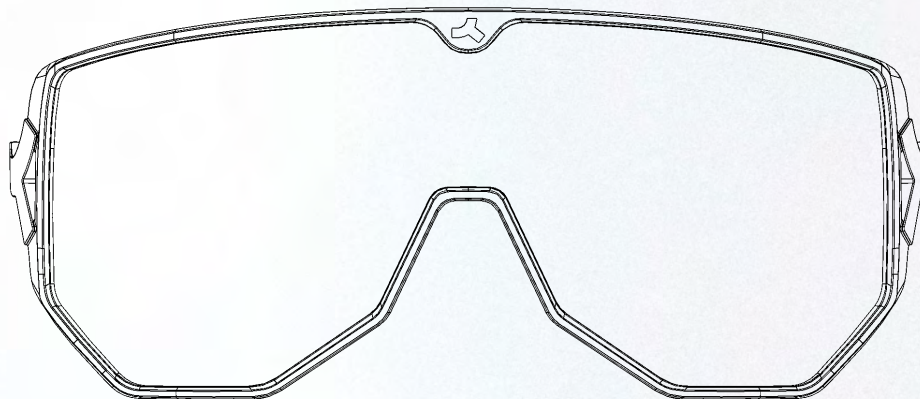

Goggles

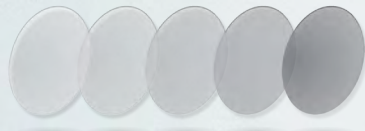

TRI-X | Chromic

Indoor & night



Cloudy days



Bright & sunny days



109 Tumba Peak



TG0003G008

Frame: Shiny transparent black

Lens: Smoke with blue multi. Cat 1-3

Goggles

TRI-X | UltraVue



Contrast enhancer



Low light conditions



102 Nafkopf



TRIG10205
Frame: Shiny transparent black
Lens: Orange/blue multi. Cat 1



TRIG10206
Frame: Shiny transparent black
Lens: Violet/blue multi. Cat 2

109 Tumba Peak



TG0003G006
Frame: Shiny transparent black
Lens: Orange/blue multi. Cat 1



TG0003G007
Frame: Shiny transparent black
Lens: Violet/blue multi. Cat 2

109 Tumba Peak Small



TG0004G006
Frame: Shiny transparent black
Lens: Orange/blue multi. Cat 1



TG0004G007
Frame: Shiny transparent black
Lens: Violet/blue multi. Cat 2

WHY TRIPOINT SPORTS GLASSES?



Biobased nylon frame: Tripoint Sports Glasses are meticulously engineered and crafted using top-tier bio-based materials, ensuring durability in the face of challenging conditions, lasting for seasons of intense sports activities.

Optimal Visibility: These sports glasses deliver unparalleled visibility, thanks to cutting-edge lens technology that enhances clarity and minimizes glare with 100% UV-protection. Whether you're cycling, skiing, or participating in outdoor adventures, Tripoint Sports Glasses offer crystal-clear vision.

Customized Comfort: Tailored for comfort, Tripoint Sports Glasses are often adjustable in both nose (Tri-click nose system™) and temples (Tri-bend temple tips™) to securely fit any face shape. Their ergonomic design minimizes pressure points, allowing you to concentrate on your athletic pursuits without distraction.

Lightweight Design: Recognizing the need for agility in sports, Tripoint Sports Glasses boast a lightweight design. Say goodbye to the burden of heavy eyewear, empowering you to navigate challenging terrain effortlessly and focus on your athletic pursuits with unmatched ease.

Trusted by world-class athletes: Join the ranks of elite competitors who choose Tripoint for precision, durability, and unrivaled performance. When the best athletes in the world trust Tripoint, you know you're in good company.



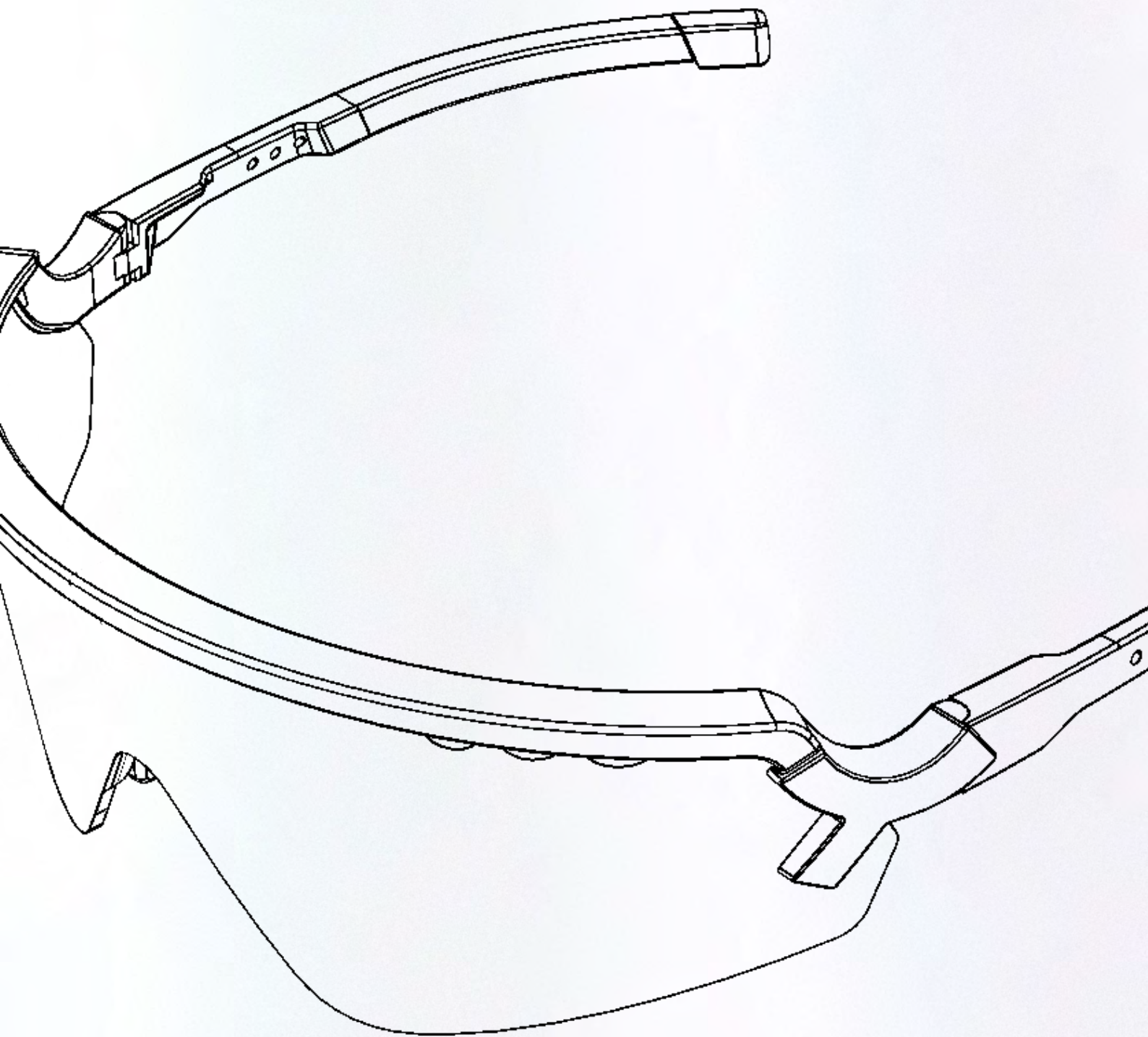

69°03'35"N 20°32'49"E

001 Treriksörset

Tech & Soul

BIO-
BASED

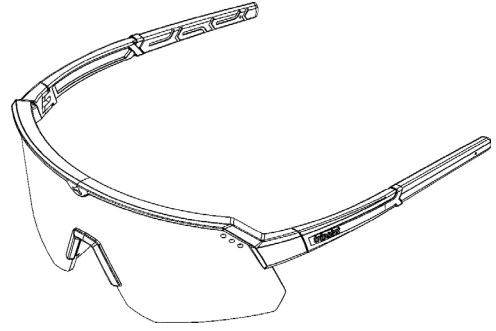

Description

30 years of experience in the sport and fashion eyewear industry has led us to this style - 001 Treriksörset. Treriksörset is the ideal model for speed sports such as mountain biking, road biking or skiing. But still just as stylish to be able to fit on a catwalk. A sober and pure design, combining style and technicality: Its wrap-around lens offers optimal protection against the wind generated by speed, but also against branches that you may encounter on your way.

Enjoy increased peripheral vision and clarity with the biobased Nylon lens, an essential factor in improving your visual accuracy and therefore, your sporting performance! Its 100% UV protective lens will counteract tired eyes for many years to come.

A durable model designed to last: 001 Treriksörset is made of 45% organic polyamide sourced from castor oil, carefully selected for its lightness, flexibility and resistance to shocks.

Keep your 001 Treriksörset in top condition: the storage pouch is specially designed to keep your shades safe. And the cleaning wipe keeps the dirt away, for permanent visual comfort.

Standards

This model meets the standards EN ISO 12312-1, AS/NZS 1067 & ANSI Z80.3 for sunglasses.

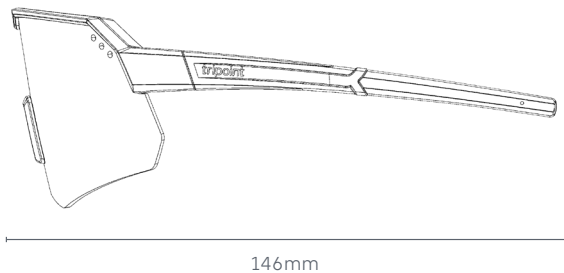

146mm

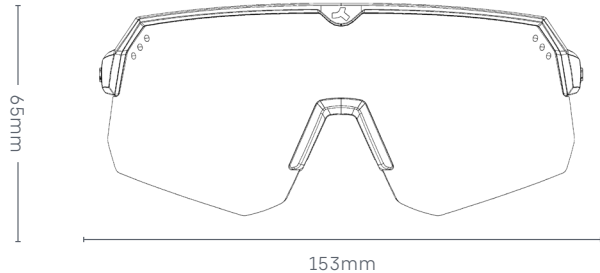

65mm

153mm

Technical Features

Tri-click nose System

The unique system makes the nose part easy to adjust and maintains the shape that the user himself specified. The nose part is rubber-coated and provides the user with comfort during longer and tougher forms of activity.

Tri-bend temple tips

The rubberized temple tips are adaptable and easy to adjust to your head for a stable and comfortable use for extended periods.

Tri-field wrap-around

The wrap-around frame provides a wide field of vision and enhanced peripheral eyesight to ensure optimal visual accuracy and improve your sports performance.

Biobased Nylon frame

The frame is made of 45% organic sourced polyamide with castor oil. The nylon material is both strong and light weighted. The Frame puts minimal strain on the nose, ears and environment at the same time.

Biobased Nylon lens

The Biobased Nylon lens is both lighter and provides a clearer view than Polycarbonate, which is the most common material for lenses in sports glasses. The lens is flexible, resistant and has a good "memory". If you bump or bend them, they will return to their original shape. Nylon as a material is also free from BPA which is a chemically harmful substance for the body.

Hydrophobic/Oleophobic

Our top of the line Hydrophobic + Oleophobic treatment ensures water, oil and dirt pearl off your lenses.

Tri-dot ventilation

The right amount of air ventilation can be important to keep the fog away. Our tri-dots provide the user with enough air circulation for a fog-free experience.

100% UV400 Protection

Our lenses block all harmful UVA, UVB & UVC light rays with wavelengths up to 400 nanometers – regardless of sun or cloud conditions.

Interchangeable lens

The weather conditions can suddenly change, then it might be handy to have a spare lens ready. On this frame, you can easily change from one lens to a lens that is best suited for the moment. Spare lenses are available for purchase.

Optical insert (available as an accessory)

RX-able optical insert which can be taken to an optician and fitted with your own prescription lenses.

Click hinge

High quality click hinge for a long-lasting temple. Free from squeaking sound, loose screws and unexpected folding.

Overview

001 Treriksroset

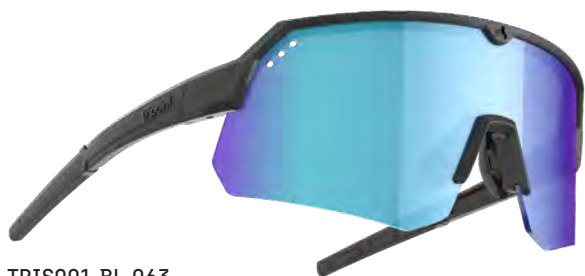

TRIS001-BL-063
 Frame: Matt black
 Lens: Biobased nylon smoke/blue multi. Cat 3



TRIS001-BR-103G
 Frame: Transparent brown
 Lens: Biobased nylon gradient brown. Cat 2



TRIS001-BL-003
 Frame: Matt black
 Lens: Biobased nylon smoke. Cat 3



TRIS001-BE-073
 Frame: Matt turquoise
 Lens: Biobased nylon smoke/pink multi. Cat 3



TRIS001-GN-793
 Frame: Matt dark petrol
 Lens: Biobased nylon Pink/silver mirror. Cat 3



TRIS001-PN-693
 Frame: Matt pink
 Lens: Biobased nylon blue/silver mirror. Cat 3

Spare lenses



Art.No	Spare lens
TRISL001-8	Clear - CAT 0
TRISL001-7	Pink - CAT 1
TRISL001001	Polarized Brown w silver mirror - CAT 3
TRISL001002	UltraVue Orange with blue multi - CAT 1
TRISL001003	UltraVue Purple with blue multi - CAT 2
TRISL001004	Smoke with blue multi - CAT 3

Optical adapter



Art.No	Color
TRIS001-OA-BL	Black
TRIS001-OA-WH	White
TRIS001-OA-BR	Transparent brown
TRIS001-OA-BE	Petrol
TRIS001-OA-PI	Powder pink
TRIS001-OA-RD	Burgundy
TRIS001-OA-YL	Transparent yellow
TRIS001-OA-BET	Transparent turquoise

27°53'N 88°8'E

002 Jongsong Peak

Free & Strong

BI^o-
BASED

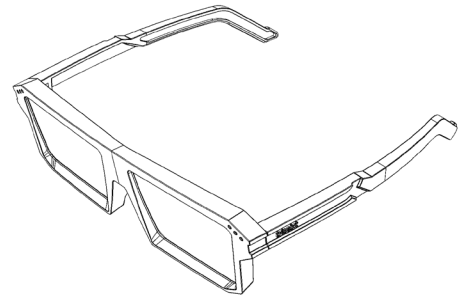

Description

Innovative hybrid frame that flirts with the eyewear fashion industry. 002 Jongsong Peak is a versatile model that works best when your everyday life flows into one. You want to train, work, study, travel, have coffee and go to a party. But can't you have only one pair of glasses for all of that? Well... Jongsong Peak allows you to mix function, technology and fashion awareness. All at the same time.

Enjoy crisp and clear vision with the biobased Nylon lens, an essential factor in improving your visual accuracy and therefore, your sporting performance! Its 100% UV protective lens will counteract tired eyes for many years to come.

A durable model designed to last: 002 Jongsong Peak is made of 45% organic polyamide sourced from castor oil, carefully selected for its lightness, flexibility and resistance to shocks.

Keep your 002 Jongsong Peak in top condition: the storage pouch is specially designed to keep your shades safe. And the cleaning wipe keeps the dirt away, for permanent visual comfort.

Standards

This model meets the standards EN ISO 12312-1, AS/NZS 1067 & ANSI Z80.3 for sunglasses.

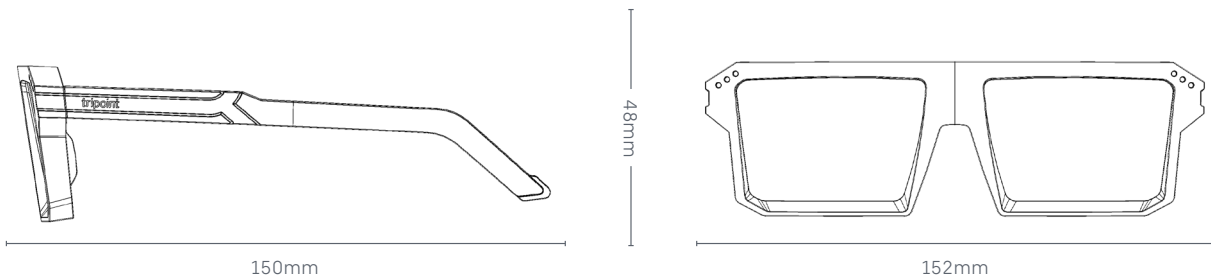

Technical Features

Comfy rubber temple tips

The rubberized temple tips are adaptable and easy to adjust to your head for a stable and comfortable use for extended periods.

Biobased Nylon frame

The frame is made of 45% organic sourced polyamide with castor oil. The nylon material is both strong and light weighted. The Frame puts minimal strain on the nose, ears and environment at the same time.

Biobased Nylon lens

The Biobased Nylon lens is both lighter and provides a clearer view than Polycarbonate, which is the most common material for lenses in sports glasses. The lens is flexible, resistant and has a good "memory". If you bump or bend them, they will return to their original shape. Nylon as a material is also free from BPA which is a chemically harmful substance for the body.

Hydrophobic/Oleophobic

Our top of the line Hydrophobic + Oleophobic treatment ensures water, oil and dirt pearl off your lenses.

100% UV400 Protection

Our lenses block all harmful UVA, UVB & UVC light rays with wavelengths up to 400 nanometers – regardless of sun or cloud conditions.

Click hinge

High quality click hinge for a long-lasting temple. Free from squeaking sound, loose screws and unexpected folding.

Overview

002 Jongsong Peak



TRIS002-BL-003
Frame: Matt black
Lens: Biobased nylon smoke. Cat 3



TRIS002-BL-503G
Frame: Matt black
Lens: Biobased nylon gradient green. Cat 1

46°50'53"N 10°30'18"E

003 Reschen

Life & Globe

BIO-
BASED

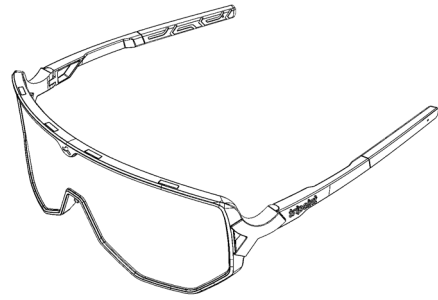

Description

003 Reschen is the perfect companion for a life in motion. The world has so much to offer, people, nature, activities, culture. You want to absorb everything, you are curious. Around the next bend, new adventures, new surprises await. Unpredictability is what makes you feel good, unpredictability is what these glasses are made for.

Enjoy increased peripheral vision and clarity with the biobased Nylon lens, an essential factor in improving your visual accuracy and therefore, your sporting performance! Its 100% UV protective lens will counteract tired eyes for many years to come.

A durable model designed to last: 003 Reschen is made of 45% organic polyamide sourced from castor oil, carefully selected for its lightness, flexibility and resistance to shocks.

Keep your 003 Reschen in top condition: the storage pouch is specially designed to keep your shades safe. And the cleaning wipe keeps the dirt away, for permanent visual comfort.

Standards

This model meets the standards EN ISO 12312-1, AS/NZS 1067 & ANSI Z80.3 for sunglasses.

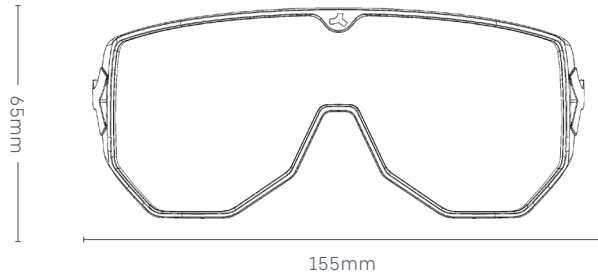
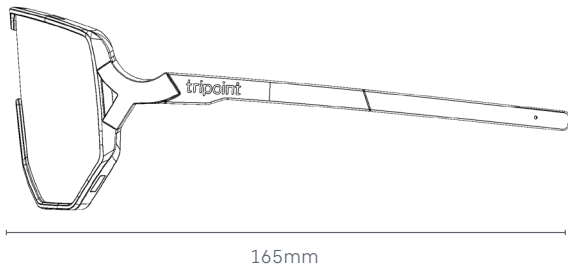

Technical Features

Tri-click nose system

The unique system makes the nose part easy to adjust and maintains the shape that the user himself specified. The nose part is rubber-coated and provides the user with comfort during longer and tougher forms of activity.

Tri-bend temple tips

The rubberized temple tips are adaptable and easy to adjust to your head for a stable and comfortable use for extended periods.

Tri-field full frame

The full-frame provides a wide field of vision and enhanced peripheral eyesight to ensure optimal visual accuracy and improve your sports performance.

Biobased Nylon frame

The frame is made of 45% organic sourced polyamide with castor oil. The nylon material is both strong and light weighted. The Frame puts minimal strain on the nose, ears and environment at the same time.

Biobased Nylon lens

The Biobased Nylon lens is both lighter and provides a clearer view than Polycarbonate, which is the most common material for lenses in sports glasses. The lens is flexible, resistant and has a good "memory". If you bump or bend them, they will return to their original shape. Nylon as a material is also free from BPA which is a chemically harmful substance for the body.

Hydrophobic/Oleophobic

Our top of the line Hydrophobic + Oleophobic treatment ensures water, oil and dirt pearl off your lenses.

100% UV400 Protection

Our lenses block all harmful UVA, UVB & UVC light rays with wavelengths up to 400 nanometers – regardless of sun or cloud conditions.

Interchangeable lens

The weather conditions can suddenly change, then it might be handy to have a spare lens ready. On this frame, you can easily change from one lens to a lens that is best suited for the moment. Spare lenses are available for purchase.

Click hinge

High quality click hinge for a long-lasting temple. Free from squeaking sound, loose screws and unexpected folding.

Overview

003 Reschen



TRIS003-BL-003
Frame: Matt black
Lens: Biobased nylon smoke. Cat 3



TRIS003-BL-063
Frame: Matt black
Lens: Biobased nylon smoke/blue multi. Cat 3



TRIS003-BR-103G
Frame: Transparent brown
Lens: Biobased nylon gradient brown. Cat 2

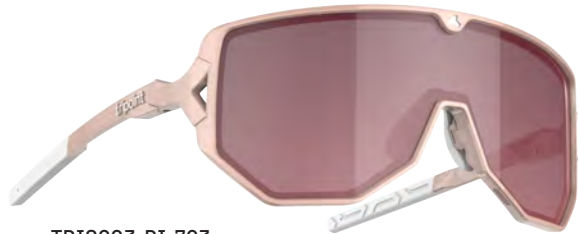

TRIS003-PI-793
Frame: Shiny milky pink
Lens: Biobased nylon pink/silver mirror. Cat 3



TRIS003-WH-203
Frame: White
Lens: Biobased nylon purple. Cat 2

Spare lenses



Art.No	Spare lens
TRISL003-8	Clear - CAT 0
TRISL003-7	Pink - CAT 1
TRISL003001	Polarized Brown w silver mirror - CAT 3
TRISL003002	UltraVue Orange with blue multi - CAT 1
TRISL003003	UltraVue Purple with blue multi - CAT 2
TRISL003004	Smoke with blue multi - CAT 3

48°00'24"N 17°09'38"E

004 Rajka

Life & Globe

BIO-BASED

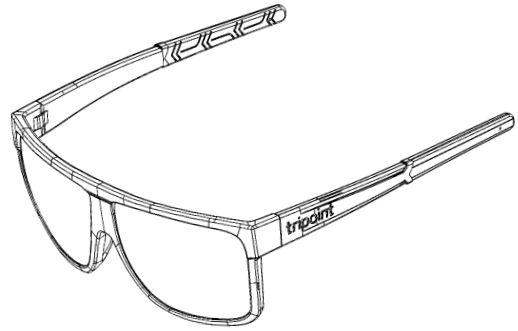

Description

004 Rajka is your go to glasses when you're on the run and don't know how the day will end up. 004 Rajka is made to fit almost any situation.

The lens in Polycarbonate has high impact resistance and a good optical quality for clear and crisp vision. Its 100% UV protective lens will block all harmful light rays, no matter weather condition.

Keep your 004 Rajka in top condition: the storage pouch is specially designed to keep your shades safe. And the cleaning wipe keeps the dirt away, for permanent visual comfort.

Standards

This model meets the standards EN ISO 12312-1, AS/NZS 1067 & ANSI Z80.3 for sunglasses.

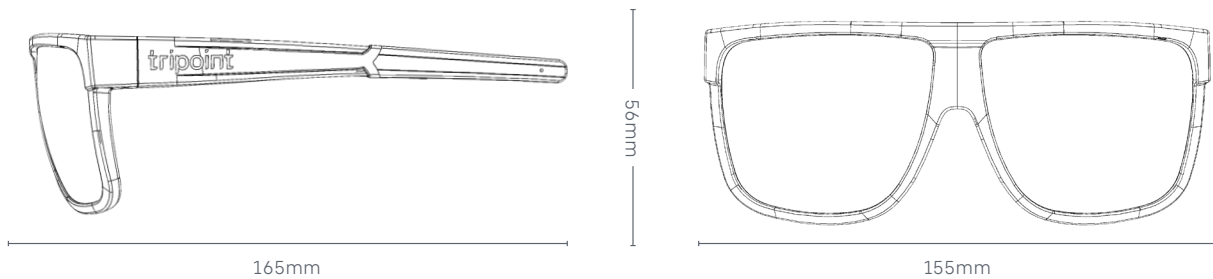

Technical Features

Tri-Bend Temple Tips

The rubberized temple tips are adaptable and easy to adjust to your head for a stable and comfortable use for extended periods.

Tri-Field Full Frame

The full-frame provides a wide field of vision and enhanced peripheral vision to ensure optimal reflexes and improve your sports performance.

Biobased Nylon frame

The frame is made of 45% organic sourced polyamide with castor oil. The nylon material are both strong and light weighted. The Frame puts minimal strain on the nose, ears and environment at the same time.

Polycarbonate lens

The lens in Polycarbonate has high impact resistance and a good optical quality for clear and crisp vision.

Hydrophobic/Oleophobic

Our top of the line Hydrophobic + Oleophobic treatment ensures water, oil and dirt pearl off your lenses.

100% UV400 Protection

Our lenses block all harmful UVA, UVB & UVC light rays with wavelengths up to 400 nanometers – regardless of sun or cloud conditions.

Click hinge

High quality click hinge for a long-lasting temple. Free from squeaking sound, loose screws and unexpected folding.

Overview

004 Rajka



TRIS004-BL-003
Frame: Matt black
Lens: Smoke. Cat 3



TRIS004-BR-103G
Frame: Transparent brown
Lens: Gradient brown. Cat 3

1°0'S 33°55'E

005 Lake Victoria

Tech & Soul

BIO-BASED

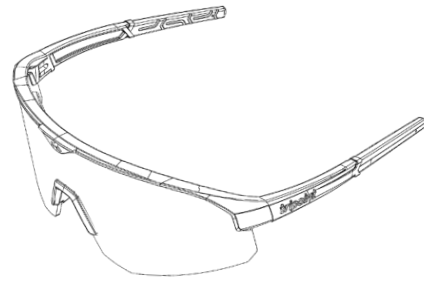

Description

Elevate your performance and style with the 005 Lake Victoria sports glasses.

Experience the pinnacle of sports eyewear innovation with the 005 Lake Victoria model. Crafted to excel in speed sports like mountain biking, road biking, and skiing, it seamlessly merges function and fashion. environment.

Its refined design effortlessly marries form and function. The wrap-around lens provides unparalleled protection against wind and obstacles, offering a blend of elegance and performance.

The wide polycarbonate lens provide peripheral vision, clarity and high impact resistance. Equipped with a 100% UV protective lens, Lake Victoria

safeguards against tired eyes and the effects of harmful rays.

005 Lake Victoria is designed to withstand the test of time, the frame is made from 45% organic polyamide sourced from castor oil. This ensures lightweight flexibility, while its shock resistance guarantees longevity.

Keep your 005 Lake Victoria sports glasses in mint condition with the tailored storage pouch. The included cleaning wipe ensures lasting visual comfort by keeping dirt at bay.

Standards

This model meets the standards EN ISO 12312-1, AS/NZS 1067 & ANSI Z80.3 for sunglasses.

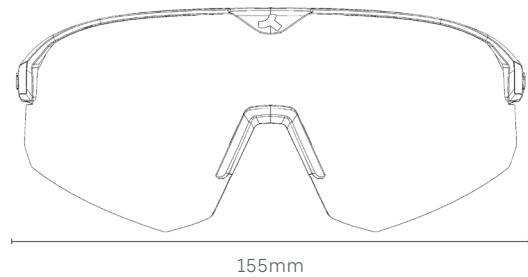
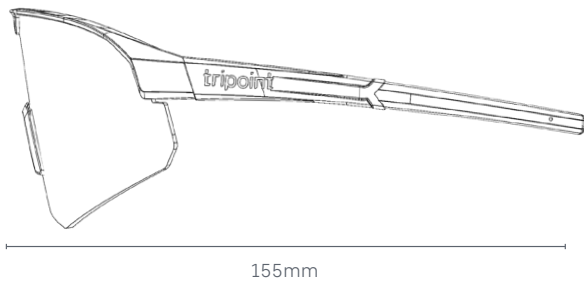

Technical Features

Tri-click nose System

The unique system makes the nose part easy to adjust and maintains the shape that the user himself specified. The nose part is rubber-coated and provides the user with comfort during longer and tougher forms of activity.

Tri-Bend Temple Tips

The rubberized temple tips are adaptable and easy to adjust to your head for a stable and comfortable use for extended periods.

Tri-field wrap-around

The wrap-around frame provides a wide field of vision and enhanced peripheral eyesight to ensure optimal visual accuracy and improve your sports performance.

Biobased Nylon frame

The frame is made of 45% organic sourced polyamide with castor oil. The nylon material are both strong and light weighted. The Frame puts minimal strain on the nose, ears and environment at the same time.

Polycarbonate lens

The lens in Polycarbonate has high impact resistance and a good optical quality for clear and crisp vision.

Interchangeable lens

The weather conditions can suddenly change, then it might be handy to have a spare lens ready. On this frame, you can easily change from one lens to a lens that is best suited for the moment. Spare lenses are available for purchase.

Hydrophobic/Oleophobic

Our top of the line Hydrophobic + Oleophobic treatment ensures water, oil and dirt peel off your lenses.

100% UV400 Protection

Our lenses block all harmful UVA, UVB & UVC light rays with wavelengths up to 400 nanometers – regardless of sun or cloud conditions.

Click hinge

High quality click hinge for a long-lasting temple. Free from squeaking sound, loose screws and unexpected folding.

Overview

005 Lake Victoria



TRIS005-BL-063
Frame: Matt black
Lens: Brown/ice blue multi. Cat 3



TRIS005-WH-063
Frame: Matt black
Lens: Smoke/ice blue multi. Cat 3



TRIS005-PN-173
Frame: Matt light pink
Lens: Brown/pink multi. Cat 3

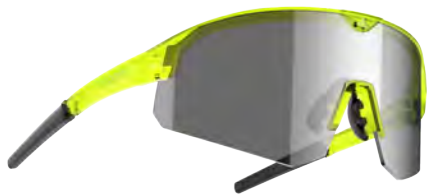

TRIS005-YL-123
Frame: Transparent neon yellow
Lens: Smoke. Cat 3



TRIS005-RD-173
Frame: Matt burgundy
Lens: Brown/pink multi. Cat 3



TRIS005-BE-173
Frame: Transparent neon turquoise
Lens: Brown/pink multi. Cat 3



TRIS00509
Frame: Matt black
Lens: Smoke. Cat 3



TRIS00510
Frame: Matt white
Lens: Smoke. Cat 3



TRIS00511
Frame: Matt pink
Lens: Smoke. Cat 3

Spare parts



Art.No

TRISL005-8
TRISL005-7
TRIS005E101
TRIS005E102
TRIS005E104
TRIS005E105

Spare lens

Clear - CAT 0
Pink - CAT 1
Smoke with ice blue multi - CAT 3
Brown with pink multi - CAT 3
UltraVue orange with blue multi - CAT 1
UltraVue purple with blue multi - CAT 2

Art.No

TRIS001-OA-BL
TRIS001-OA-WH
TRIS001-OA-BR
TRIS001-OA-BE
TRIS001-OA-PI
TRIS001-OA-RD
TRIS001-OA-YL
TRIS001-OA-BET

Optical adapter

Black
White
Transparent brown
Petrol
Powder pink
Burgundy
Transparent yellow
Transparent turquoise



TRIS00512
Frame: Camo green
Lens: Smoke. Cat 3

006 1°0'S 33°55'E Lake Victoria Small

Tech & Soul

BIO-
BASED

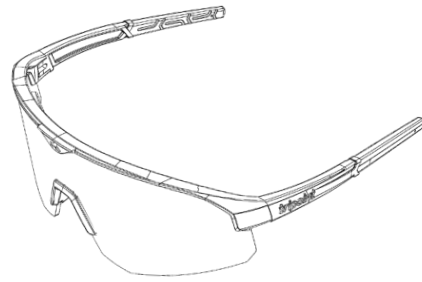

Description

Elevate your performance and style with the 006 Lake Victoria small sports glasses.

Experience the pinnacle of sports eyewear innovation with the 006 Lake Victoria small model. Crafted to excel in speed sports like mountain biking, road biking, and skiing, it seamlessly merges function and fashion. environment.

Its refined design effortlessly marries form and function. The wrap-around lens provides unparalleled protection against wind and obstacles, offering a blend of elegance and performance.

The wide polycarbonate lens provide peripheral vision, clarity and high impact resistance. Equipped with a 100% UV protective lens, Lake Victoria

safeguards against tired eyes and the effects of harmful rays.

006 Lake Victoria is designed to withstand the test of time, the frame is made from 45% organic polyamide sourced from castor oil. This ensures lightweight flexibility, while its shock resistance guarantees longevity.

Keep your 006 Lake Victoria small sports glasses in mint condition with the tailored storage pouch. The included cleaning wipe ensures lasting visual comfort by keeping dirt at bay.

Standards
This model meets the standards EN ISO 12312-1, AS/NZS 1067 & ANSI Z80.3 for sunglasses.

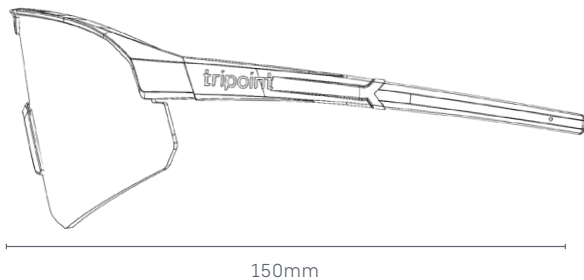

60mm

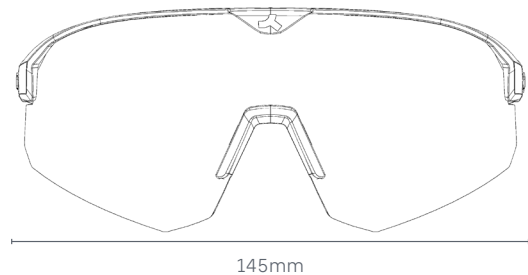

145mm

Technical Features

Tri-click nose System

The unique system makes the nose part easy to adjust and maintains the shape that the user himself specified. The nose part is rubber-coated and provides the user with comfort during longer and tougher forms of activity.

Tri-Bend Temple Tips

The rubberized temple tips are adaptable and easy to adjust to your head for a stable and comfortable use for extended periods.

Tri-field wrap-around

The wrap-around frame provides a wide field of vision and enhanced peripheral eyesight to ensure optimal visual accuracy and improve your sports performance.

Biobased Nylon frame

The frame is made of 45% organic sourced polyamide with castor oil. The nylon material are both strong and light weighted. The Frame puts minimal strain on the nose, ears and environment at the same time.

Polycarbonate lens

The lens in Polycarbonate has high impact resistance and a good optical quality for clear and crisp vision.

Interchangeable lens

The weather conditions can suddenly change, then it might be handy to have a spare lens ready. On this frame, you can easily change from one lens to a lens that is best suited for the moment. Spare lenses are available for purchase.

Hydrophobic/Oleophobic

Our top of the line Hydrophobic + Oleophobic treatment ensures water, oil and dirt peel off your lenses.

100% UV400 Protection

Our lenses block all harmful UVA, UVB & UVC light rays with wavelengths up to 400 nanometers – regardless of sun or cloud conditions.

Click hinge

High quality click hinge for a long-lasting temple. Free from squeaking sound, loose screws and unexpected folding.

Overview

006 Lake Victoria small



TRIS006-BL-063
Frame: Matt black
Lens: Brown/ice blue multi. Cat 3



TRIS006-WH-063
Frame: Matt black
Lens: Smoke/ice blue multi. Cat 3



TRIS006-PN-173
Frame: Matt light pink
Lens: Brown/pink multi. Cat 3



TRIS006-YL-003
Frame: Transparent neon yellow
Lens: Smoke. Cat 3



TRIS006-RD-173
Frame: Matt burgundy
Lens: Brown/pink multi. Cat 3



TRIS006-BE-173
Frame: Transparent neon turquoise
Lens: Brown/pink multi. Cat 3



TRIS00613
Frame: Matt black
Lens: Smoke. Cat 3



TRIS00612
Frame: Matt white
Lens: Smoke. Cat 3



TRIS00610
Frame: Matt pink
Lens: Smoke. Cat 3

Spare parts



Art.No

TRISL006-8
TRISL006-7
TRISL006E101
TRISL006E102
TRISL006E104
TRISL006E105

Spare lens

Clear - CAT 0
Pink - CAT 1
Smoke with ice blue multi - CAT 3
Brown with pink multi - CAT 3
UltraVue orange with blue multi - CAT 1
UltraVue purple with blue multi - CAT 2

Art.No

TRIS001-OA-BL
TRIS001-OA-WH
TRIS001-OA-BR
TRIS001-OA-BE
TRIS001-OA-PI
TRIS001-OA-RD
TRIS001-OA-YL
TRIS001-OA-BET

Optical adapter

Black
White
Transparent brown
Petrol
Powder pink
Burgundy
Transparent yellow
Transparent turquoise



TRIS00611
Frame: Camo green
Lens: Smoke. Cat 3

007 17°47'16"S 25°15'24"E Chobe

Tech & Soul

BIO-
BASED

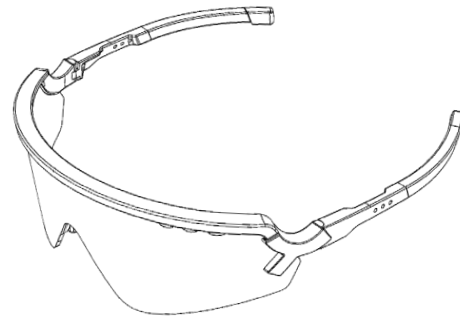

Description

Elevate your performance and step up your style game with the remarkable 007 Chobe sports glasses. These versatile frames are carefully engineered to cater to your every multisport need. The high basecurve design ensures a snug fit against your face, making them the perfect choice for both gusty winds and radiant sunshine.

Crafted to excel in high-speed sports such as mountain biking, road biking, surfing and skiing, it effortlessly blends fashion with function.

Its sleek design seamlessly marries aesthetics and practicality. The wrap-around lens offers unmatched protection against wind and obstacles, marrying elegance with top-tier performance. It's like having a second skin glued to your face.

The wide polycarbonate lens delivers exceptional peripheral vision, crystal-clear clarity, and remarkable high-im-

pact resistance. Equipped with a 100% UV protective lens, the 007 Chobe safeguards your eyes against fatigue and the harmful effects of UV rays.

Designed for longevity, the 007 Chobe frame is constructed from 45% organic polyamide sourced from castor oil. This ensures lightweight flexibility, while its shock resistance guarantees lasting durability.

To maintain the pristine condition of your 008 Lake Prespa sports glasses, we offer a customized storage pouch that doubles as a cleaning cloth. Additionally, you'll receive a hard case with a magnetic lock, and it can be flat-packed for convenience.

Standards

This model meets the standards EN ISO 12312-1, AS/NZS 1067 & ANSI Z80.3 for sunglasses.

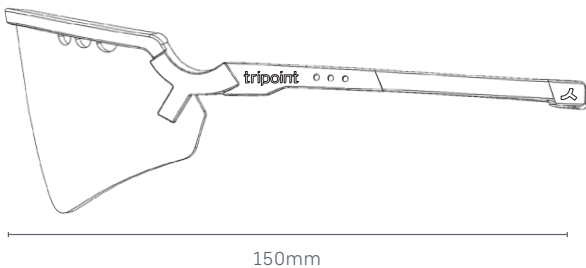

60mm

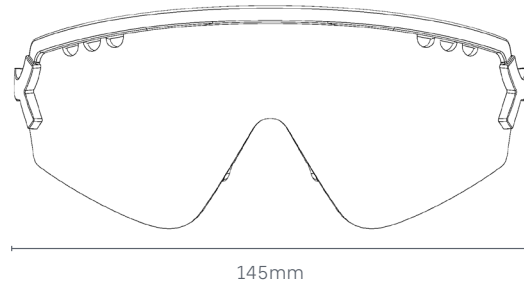

145mm

Technical Features

Tri-flex Nose System

This unique system allows for easy adjustment of the nose piece at any angle specified by the user. The nose piece is rubber-coated, providing comfort during extended and more strenuous activities.

Tri-Bend Temple Tips

The rubberized temple tips are adaptable and easy to adjust to your head for a stable and comfortable use for extended periods.

Tri-field wrap-around

The wrap-around frame provides a wide field of vision and enhanced peripheral eyesight to ensure optimal visual accuracy and improve your sports performance.

Biobased Nylon frame

The frame is made of 45% organic sourced polyamide with castor oil. The nylon material are both strong and light weighted. The Frame puts minimal strain on the nose, ears and environment at the same time.

Polycarbonate lens

The lens in Polycarbonate has high impact resistance and a good optical quality for clear and crisp vision.

Interchangeable lens

The weather conditions can suddenly change, then it might be handy to have a spare lens ready. On this frame, you can easily change from one lens to a lens that is best suited for the moment. Spare lenses are available for purchase.

Hydrophobic/Oleophobic

Our top of the line Hydrophobic + Oleophobic treatment ensures water, oil and dirt pearl off your lenses.

100% UV400 Protection

Our lenses block all harmful UVA, UVB & UVC light rays with wavelengths up to 400 nanometers – regardless of sun or cloud conditions.

Click hinge

High quality click hinge for a long-lasting temple. Free from squeaking sound, loose screws and unexpected folding.

Floating Neck Cord

Included with your sports glasses is an attachable neck cord for added convenience. This neck cord boasts a unique floating feature, ensuring that should you accidentally drop your glasses in the water, they'll stay afloat and easily retrievable.

Moreover, it's a handy accessory if you prefer to keep your glasses hanging around your neck when they're not in use. With this floating neck cord, you get both practical functionality and peace of mind, making it a valuable addition to your sports eyewear.

Overview

007 Chobe



TS0007S011
Frame: Matt light purple
Lens: Purple/purple multi. Cat 3

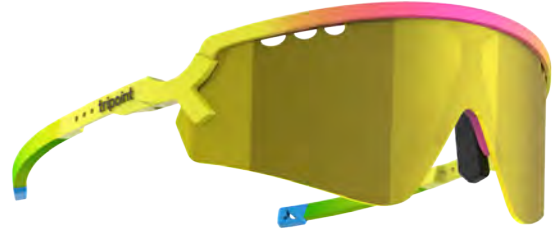

TS0007S012
Frame: Multi color
Lens: Brown/yellow multi. Cat 3



TS0007S013
Frame: Matt black
Lens: Brown/bronze multi. Cat 3



TS0007S014
Frame: Matt yellow
Lens: Brown/purple multi. Cat 3

Spare lenses



Art.No	Spare lens
TS007E101	Smoke w Ice blue multi - CAT 3
TS007E102	Brown w Pink Multi - CAT 3
TS007E104	UltraVue Orange with blue multi - CAT 1
TS007E105	UltraVue Purple with blue multi CAT 2
TS007E106	Clear - CAT 0

008 40°51'06"N 20°59'00"E Lake Prespa

Life & Globe

BIO-BASED

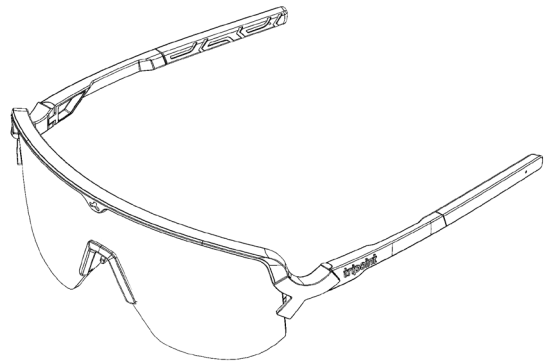

Description

Embrace the half-frame allure with a bio-based nylon frame that effortlessly balances sporty functionality with casual elegance. The hybrid design caters to both active pursuits and laid-back occasions, offering versatility for any setting.

Ideal for activities like: Running, cycling, hiking and climbing. After completing your sport, seamlessly transition from athletic activities to leisure, highlighting its versatile appeal.

Its characteristic yet sleek design effortlessly combines aesthetics and practicality. The straight lens with a low base curve provides unparalleled protection against wind and obstacles, blending elegance with top-tier performance.

The polycarbonate lens not only provides clarity but also shields against wind, dirt, and bugs, ensuring a comfortable experience.

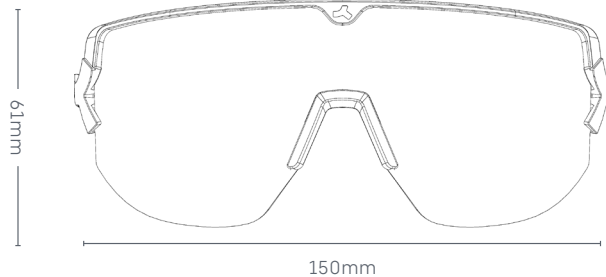
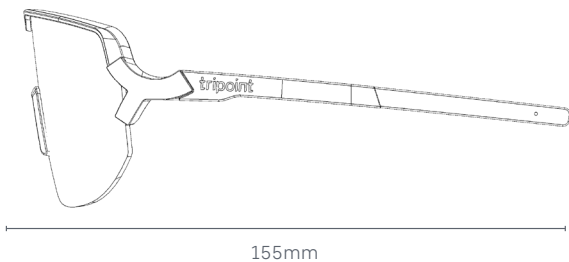

Equipped with a 100% UV protective lens, the 008 Lake Prespa protect your eyes against fatigue and the harmful effects of UV rays.

Designed for longevity, the 008 Lake Prespa frame is constructed from 45% organic polyamide sourced from castor oil. This ensures lightweight flexibility, while its shock resistance guarantees lasting durability.

To maintain the pristine condition of your 008 Lake Prespa sports glasses, we offer a customized storage pouch that doubles as a cleaning cloth. Additionally, you'll receive a hard case with a magnetic lock, and it can be flat-packed for convenience.

Standards

This model meets the standards EN ISO 12312-1, AS/NZS 1067 & ANSI Z80.3 for sunglasses.

Technical Features

Tri-click nose system

The unique system makes the nose part easy to adjust and maintains the shape that the user himself specified. The nose part is rubber-coated and provides the user with comfort during longer and tougher forms of activity.

Tri-Bend Temple Tips

The rubberized temple tips are adaptable and easy to adjust to your head for a stable and comfortable use for extended periods.

Tri-field half frame

The full-frame provides a wide field of vision and enhanced peripheral eyesight to ensure optimal visual accuracy and improve your sports performance.

Biobased Nylon frame

The frame is made of 45% organic sourced polyamide with castor oil. The nylon material are both strong and light weighted. The Frame puts minimal strain on the nose, ears and environment at the same time.

Polycarbonate lens

The lens in Polycarbonate has high impact resistance and a good optical quality for clear and crisp vision.

Interchangeable lens

The weather conditions can suddenly change, then it might be handy to have a spare lens ready. On this frame, you can easily change from one lens to a lens that is best suited for the moment. Spare lenses are available for purchase.

Hydrophobic/Oleophobic

Our top of the line Hydrophobic + Oleophobic treatment ensures water, oil and dirt pearl off your lenses.

100% UV400 Protection

Our lenses block all harmful UVA, UVB & UVC light rays with wavelengths up to 400 nanometers – regardless of sun or cloud conditions.

Click hinge

High quality click hinge for a long-lasting temple. Free from squeaking sound, loose screws and unexpected folding.

Overview

008 Lake Prespa



TS0008S014
Frame: Matt black
Lens: Brown/red multi. Cat 3



TS0008S015
Frame: Matt metallic white
Lens: Brown/red multi. Cat 3



TS0008S013
Frame: Shiny neon orange
Lens: Smoke. Cat 3



TS0008S009
Frame: Matt black
Lens: Smoke. Cat 3

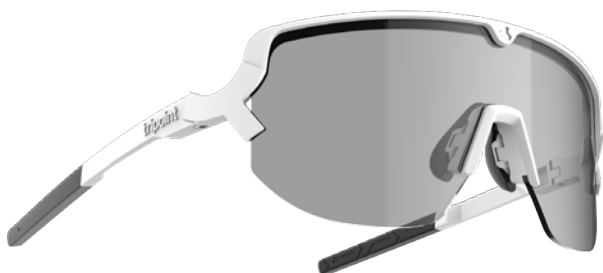

TS0008S006
Frame: Matt white
Lens: Smoke. Cat 3



TS0008S004
Frame: Matt pink
Lens: Smoke. Cat 3



TS0008S012
Frame: Matt camo green
Lens: Smoke. Cat 3

009 40°51'06"N 20°59'00"E Lake Prespa

Life & Globe

BIO-BASED

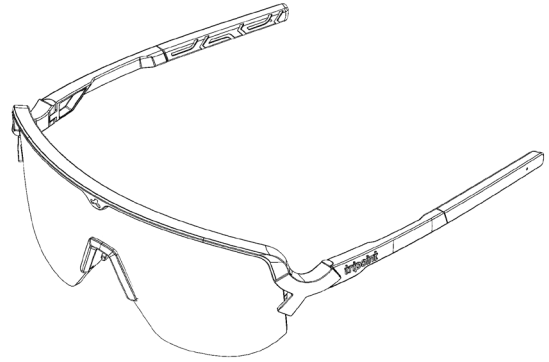

Description

Embrace the half-frame allure with a bio-based nylon frame that effortlessly balances sporty functionality with casual elegance. The hybrid design caters to both active pursuits and laid-back occasions, offering versatility for any setting.

Ideal for activities like: Running, cycling, hiking and climbing. After completing your sport, seamlessly transition from athletic activities to leisure, highlighting its versatile appeal.

Its characteristic yet sleek design effortlessly combines aesthetics and practicality. The straight lens with a low base curve provides unparalleled protection against wind and obstacles, blending elegance with top-tier performance.

The polycarbonate lens not only provides clarity but also shields against wind, dirt, and bugs, ensuring a comfortable experience.

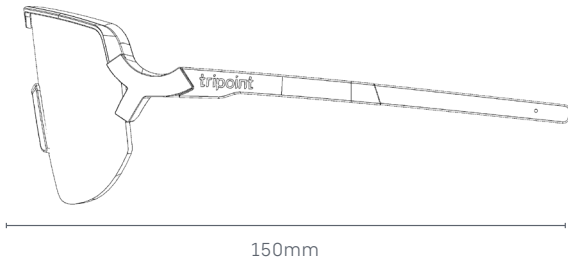

150mm

Equipped with a 100% UV protective lens, the 009 Lake Prespa Small protect your eyes against fatigue and the harmful effects of UV rays.

Designed for longevity, the 009 Lake Prespa Small frame is constructed from 45% organic polyamide sourced from castor oil. This ensures lightweight flexibility, while its shock resistance guarantees lasting durability.

To maintain the pristine condition of your 009 Lake Prespa Small sports glasses, we offer a customized storage pouch that doubles as a cleaning cloth. Additionally, you'll receive a hard case with a magnetic lock, and it can be flat-packed for convenience.

Standards

This model meets the standards EN ISO 12312-1, AS/NZS 1067 & ANSI Z80.3 for sunglasses.

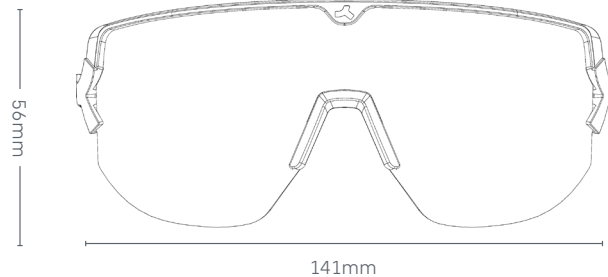

141mm

Technical Features

Tri-click nose system

The unique system makes the nose part easy to adjust and maintains the shape that the user himself specified. The nose part is rubber-coated and provides the user with comfort during longer and tougher forms of activity.

Tri-Bend Temple Tips

The rubberized temple tips are adaptable and easy to adjust to your head for a stable and comfortable use for extended periods.

Tri-field half frame

The full-frame provides a wide field of vision and enhanced peripheral eyesight to ensure optimal visual accuracy and improve your sports performance.

Biobased Nylon frame

The frame is made of 45% organic sourced polyamide with castor oil. The nylon material are both strong and light weighted. The Frame puts minimal strain on the nose, ears and environment at the same time.

Polycarbonate lens

The lens in Polycarbonate has high impact resistance and a good optical quality for clear and crisp vision.

Interchangeable lens

The weather conditions can suddenly change, then it might be handy to have a spare lens ready. On this frame, you can easily change from one lens to a lens that is best suited for the moment. Spare lenses are available for purchase.

Hydrophobic/Oleophobic

Our top of the line Hydrophobic + Oleophobic treatment ensures water, oil and dirt pearl off your lenses.

100% UV400 Protection

Our lenses block all harmful UVA, UVB & UVC light rays with wavelengths up to 400 nanometers – regardless of sun or cloud conditions.

Click hinge

High quality click hinge for a long-lasting temple. Free from squeaking sound, loose screws and unexpected folding.

Overview

009 Lake Prespa Small



TS0008S014
Frame: Matt black
Lens: Brown/red multi. Cat 3



TS0008S015
Frame: Matt metallic white
Lens: Brown/red multi. Cat 3



TS0008S013
Frame: Shiny neon orange
Lens: Smoke. Cat 3



TS0008S009
Frame: Matt black
Lens: Smoke. Cat 3

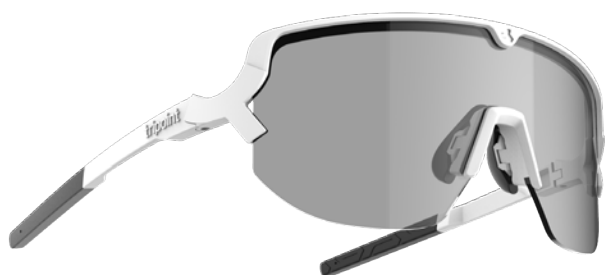

TS0008S006
Frame: Matt white
Lens: Smoke. Cat 3



TS0008S004
Frame: Matt pink
Lens: Smoke. Cat 3



TS0008S012
Frame: Matt camo green
Lens: Smoke. Cat 3

WHY TRIPPOINT SKI GOGGLES?



Quality: Tripoint Goggles are engineered with precision and crafted using high-quality materials, ensuring they can withstand the toughest conditions and last for seasons.

Visibility: These goggles offer unparalleled visibility, thanks to advanced lens technology that enhances clarity and reduces glare. Whether you're skiing, snowboarding, or engaging in other outdoor activities, Tripoint Goggles provide crystal-clear vision.

Comfortable Fit: Designed for comfort, Tripoint Goggles are adjustable to fit any face shape securely. Their ergonomic design minimizes pressure points, allowing you to focus on your adventure, not your eyewear.

Protection: Tripoint Goggles prioritize your safety. They offer excellent UV protection to shield your eyes from harmful sun rays and are built to withstand impacts, offering essential protection in high-risk sports.



Trusted by world-class athletes: Join the ranks of elite competitors who choose Tripoint for precision, durability, and unrivaled performance. When the best athletes in the world trust Tripoint, you know you're in good company.

Stylish Designs: With a range of stylish and trendy designs, Tripoint Goggles not only perform exceptionally but also make a fashion statement on the slopes or trails.

Versatility: Tripoint Goggles are versatile, suitable for various outdoor activities such as skiing, snowboarding, hiking, and more. They're an all-in-one solution for your eye protection needs.

22°24'N 102°9'E

101 Shiceng Dashan

Life & Globe

BI^o-
BASED

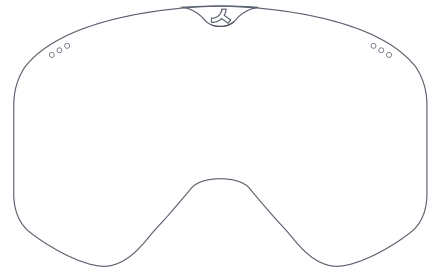

Description

Our snow goggle 001 Shiceng Dashan have been designed for all the mountain lovers and enthusiasts in mind.

Comfort, protection and practicality guaranteed: The soft and comfortable 3-layers of foam will perfectly fit the contours of your face, while the anti-slip silicone strap hold on to your helmet to ensure a safe and comfortable ride down the slopes.

The sealed double lens is anti-fog treated between the two lenses to ensure your visual comfort and clarity.

001 Shiceng Dashan is OTG-prepared and can be worn over corrective glasses and fits most of the helmets on the market.

Keep your 001 Shiceng Dashan in top condition: the storage pouch is specially designed to also act as a cleaning wipe, for permanent visual comfort.

Standards

This model complies with international standards relating to eye protection for skiing and similar activities such as snowboarding (NF EN 174).



Technical Features

Built in anti-fog shield

The goggles are by nature anti-fog resistant and prevent condensation thanks to their sealed dual-material lens (polycarbonate on the outside and acetate on the inside).

Double buckle size adjustment

The goggles are equipped with a double buckle size adjustment to ensure optimum support and easy adjustment that last.

Tri-Field Vision

The wrap-around frame provides a wide field of view and enhanced peripheral vision to ensure optimal reflexes and improve your sports performance.

Tri-dot ventilation

The right amount of air ventilation can be important to keep the fog away. Our tri-dots provide the user with enough air circulation for a fog-free experience.

100% UV400 Protection

Our lenses block all harmful UVA, UVB & UVC light rays with wavelengths up to 400 nanometers – regardless of sun or cloud conditions.

OTG-prepared

This style has a cut out in the frame and can be worn over corrective glasses

Interchangeable lens

The weather conditions can suddenly change, then it might be handy to have a spare lens ready. On this frame, you can easily change from one lens to a lens that is best suited for the moment. Spare lenses are available for purchase.

Anti-slip silicone strap

A thin line of silicone is attached to the inside of the strap and creates friction to your helmet. This prevents the goggles from falling off and ensure a safe and comfortable ride down the slopes.

Overview

101 Shiceng Dashan



TRIG101-BL-063
Frame: Matt black
Lens: Smoke/ice blue multi. Cat 3



TRIG101-BL-073
Frame: Matt black
Lens: Smoke/ice pink multi. Cat 3



TRIG101-BL-112
Frame: Matt black
Lens: Brown/gold multi. Cat 3

Spare lenses



Art.No	Spare lens
TRIG101E103	Clear - CAT 0
TRIG101E102	Purple - CAT 1

47°3'35'N 09°36'24'E

102 Nafkopf

Tech & Soul

BIO-
BASED

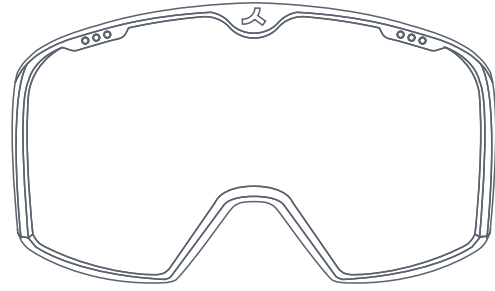

Description

Our snow goggle 002 Nafkopf is developed with several years of experience from the Alpine World Cup circus. Nothing is left to chance, every millimeter on the frame is carefully evaluated to give the user the absolute best conditions for success. You get an extraordinary field of vision thanks to the wide cylindrical lens and the precision-fitted frame. If your about to go in really high speeds, you can also buy an air blocker that blocks air flow around the entire frame. Even though it is a frame designed for the professional athlete, it of course works just as well for the exerciser.

Comfort, protection and practicality guaranteed: The soft and comfortable 3-layers of foam will perfectly fit the contours of your face, while the anti-slip silicone strap hold on to your helmet to ensure a safe and comfortable ride down the slopes.

The sealed double lens is anti-fog treated between the two lenses to ensure your visual comfort and clarity.

102 Nafkopf is OTG-prepared and can be worn over corrective glasses and fits most of the helmets on the market.

Keep your goggles in top condition: the storage pouch is specially designed to also act as a cleaning wipe, for permanent visual comfort.

Standards

This model complies with international standards relating to eye protection for skiing and similar activities such as snowboarding [NF EN 174].



Technical Features

Built in anti-fog shield

The goggles are by nature anti-fog resistant and prevent condensation thanks to their sealed dual-material lens [polycarbonate on the outside and acetate on the inside].

Double buckle size adjustment

The goggles are equipped with a double buckle size adjustment to ensure optimum support and easy adjustment that last.

Tri-Field Vision

The wrap-around frame provides a wide field of view and enhanced peripheral vision to ensure optimal reflexes and improve your sports performance.

100% UV400 Protection

Our lenses block all harmful UVA, UVB & UVC light rays with wavelengths up to 400 nanometers – regardless of sun or cloud conditions.

OTG-prepared

This style has a cut out in the frame and can be worn over corrective glasses

Interchangeable lens

The weather conditions can suddenly change, then it

might be handy to have a spare lens ready. On this frame, you can easily change from one lens to a lens that is best suited for the moment. Spare lenses are available for purchase.

Anti-slip silicone strap

A thin line of silicone is attached to the inside of the strap and creates friction to your helmet. This prevents the goggles from falling off and ensure a safe and comfortable ride down the slopes.

Airblocker (available as an accessory)

If your about to go in really high speeds, this is an air blocker that blocks air flow around the entire frame. Perfect for Giant Slalom, Downhill, Super-G.



Overview

102 Nafkopf



TRIG102-BL-061
Frame: Matt black
Lens: Light orange/blue multi. Cat 1



TRIG102-BL-063
Frame: Matt black
Lens: Smoke/ice blue multi. Cat 3



TRIG102-BE-112
Frame: Matt dark blue
Lens: Brown/gold tint multi. Cat 2



TRIG102-WH-272
Frame: Powder pink
Lens: purple with rose multi. Cat 2

TRIG103-BL-183
Frame: Matt black
Lens: Brown/red multi. Cat 3



TRIGS102-BL
Airblocker for 102 Nafkopf

Spare lenses



Art.No	Spare lens
TRIG102E101	Brown with blue multi - CAT 3
TRIG102E102	Clear - CAT 0
TRIG102E104	Purple - CAT 2
TRIG102E105	UltraVue orange with blue multi - CAT 1
TRIG102E106	UltraVue purple with blue multi CAT 2

22°48'30'S 67°10'40'W

103 Zapaleri

Free & Strong

BIO-BASED

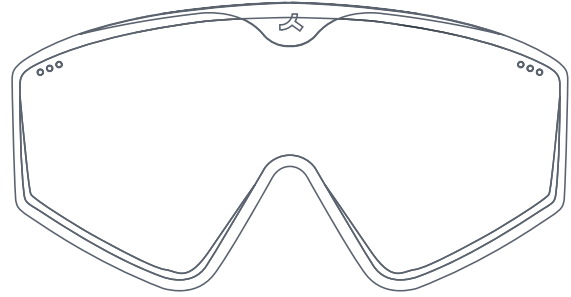

Description

103 Zapaleri pays homage to the glory days of the past in a new vintage style. Simple, efficient and brutally stylish. Although the similarities with former days are striking, the technical features are at the forefront in terms of function and technicality.

Comfort, protection and practicality guaranteed: The soft and comfortable 3-layers of foam will perfectly fit the contours of your face, while the anti-slip 30mm silicone strap hold on to your helmet to ensure a safe and comfortable ride down the slopes.

The sealed double lens is anti-fog treated between the two lenses to ensure your visual comfort and clarity.

103 Zapaleri is OTG-prepared and can be worn over corrective glasses and fits most of the helmets on the market.

A durable model designed to last: 103 Zapaleri is made of 45% organic polyamide sourced from castor oil, carefully selected for its lightness, flexibility and resistance to shocks and perspiration.

Keep your goggles in top condition: the storage pouch is specially designed to also act as a cleaning wipe, for permanent visual comfort.

Standards

This model complies with international standards relating to eye protection for skiing and similar activities such as snowboarding (NF EN 174).



Technical Features

Built in anti-fog shield

The goggles are by nature anti-fog resistant and prevent condensation thanks to their sealed dual-material lens [polycarbonate on the outside and acetate on the inside].

Double buckle size adjustment

The goggles are equipped with a double buckle size adjustment to ensure optimum support and easy adjustment that last.

Tri-Field Vision

The wrap-around frame provides a wide field of view and enhanced peripheral vision to ensure optimal reflexes and improve your sports performance.

Tri-dot ventilation

The right amount of air ventilation can be important to keep the fog away. Our tri-dots provide the user with enough air circulation for a fog-free experience.

100% UV400 Protection

Our lenses block all harmful UVA, UVB & UVC light rays with wavelengths up to 400 nanometers – regardless of sun or cloud conditions.

OTG-prepared

This style has a cut out in the frame and can be worn over corrective glasses

Interchangeable lens

The weather conditions can suddenly change, then it might be handy to have a spare lens ready. On this frame, you can easily change from one lens to a lens that is best suited for the moment. Spare lenses are available for purchase.

Anti-slip silicone strap

A thin line of silicone is attached to the inside of the strap and creates friction to your helmet. This prevents the goggles from falling off and ensure a safe and comfortable ride down the slopes.

Overview

103 Zapaleri



TRIG103-BL-183
Frame: Matt black
Lens: Brown/red multi. Cat 3



TRIG103-WH-063
Frame: Matt white
Lens: Smoke/ice blue multi. Cat 3



TRIG103-YL-023
Frame: Matt yellow
Lens: smoke/ice purple multi. Cat 3



TRIG103-LI-262
Frame: Matt lavendel
Lens: Purple/blue multi. Cat 2

Spare lenses



Art.No	Spare lens
TRIG103E101	Brown with ice blue multi - CAT 3
TRIG103E102	Clear - CAT 0
TRIG103E104	Purple - CAT 2
TRIG103E105	UltraVue orange with blue multi - CAT 1
TRIG103E106	UltraVue purple with blue multi CAT 2

1°23'S 29°36'E

109 Tumba Peak

Life & Globe



Description

Introducing the 109 Tumba Peak, a pair of large ski goggles designed to provide an expansive field of vision on the slopes.

The ventilated frame ensures optimal airflow, complemented by a triple-layer foam construction for a comfortable fit against the face.

Equipped with a silicone strap for excellent friction with the helmet, the goggles feature a ventilated frame and a sealed double lens with anti-fog treatment. The lens is also interchangeable, offering versatility for varying conditions.

With OTG (Over the Glasses) prepared design and a double buckle size adjustment, the 109 Tumba Peak

prioritizes both performance and comfort for your skiing adventures.

Keep your goggles in top condition: the goggle soc is specially designed to also act as a cleaning wipe, for permanent visual comfort.

Standards

This model complies with international standards relating to eye protection for skiing and similar activities such as snowboarding (NF EN 174).

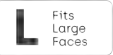

Technical Features

Built in anti-fog shield

The goggles are by nature anti-fog resistant and prevent condensation thanks to their sealed dual-material lens (polycarbonate on the outside and acetate on the inside).

Double buckle size adjustment

The goggles are equipped with a double buckle size adjustment to ensure optimum support and easy adjustment that last.

Tri-Field Vision

The wrap-around frame provides a wide field of view and enhanced peripheral vision to ensure optimal reflexes and improve your sports performance.

100% UV400 Protection

Our lenses block all harmful UVA, UVB & UVC light rays with wavelengths up to 400 nanometers – regardless of sun or cloud conditions.

OTG-prepared

This style has a cut out in the frame and can be worn over corrective glasses

Interchangeable lens

The weather conditions can suddenly change, then it might be handy to have a spare lens ready. On this frame, you can easily change from one lens to a lens that is best suited for the moment. Spare lenses are available for purchase.

Overview

109 Tumba Peak



TG0003G001
Frame: Matt black
Lens: Smoke. Cat 3



TG0003G002
Frame: Matt black
Lens: Brown with bronze multi. Cat 3



TG0003G003
Frame: Matt white
Lens: Purple with pink multi. Cat 2



TG0003G004
Frame: Matt Burgundy
Lens: Brown with pink multi. Cat 3



TG0003G005
Frame: Matt camo green
Lens: Smoke lens. Cat 3

1°23'S 29°36'E Small 110 Tumba Peak

Life & Globe



Description

Introducing the 109 Tumba Peak small, a pair of small size ski goggles designed to provide an expansive field of view.

The ventilated frame ensures optimal airflow, complemented by a triple-layer foam construction for a comfortable fit against the face.

Equipped with a silicone strap for excellent friction with the helmet, the goggles feature a ventilated frame and a sealed double lens with anti-fog treatment. The lens is also interchangeable, offering versatility for varying conditions.

With OTG (Over the Glasses) prepared design and a double buckle size adjustment, the 110 Tumba Peak Small prioritizes both performance and comfort for your skiing adventures.

Keep your goggles in top condition: the goggle soc is specially designed to also act as a cleaning wipe, for permanent visual comfort.

Standards

This model complies with international standards relating to eye protection for skiing and similar activities such as snowboarding (NF EN 174).



Technical Features

Built in anti-fog shield

The goggles are by nature anti-fog resistant and prevent condensation thanks to their sealed dual-material lens (polycarbonate on the outside and acetate on the inside).

Double buckle size adjustment

The goggles are equipped with a double buckle size adjustment to ensure optimum support and easy adjustment that last.

Tri-Field Vision

The wrap-around frame provides a wide field of view and enhanced peripheral vision to ensure optimal reflexes and improve your sports performance.

100% UV400 Protection

Our lenses block all harmful UVA, UVB & UVC light rays with wavelengths up to 400 nanometers – regardless of sun or cloud conditions.

OTG-prepared

This style has a cut out in the frame and can be worn over corrective glasses

Interchangeable lens

The weather conditions can suddenly change, then it might be handy to have a spare lens ready. On this frame, you can easily change from one lens to a lens that is best suited for the moment. Spare lenses are available for purchase.

Overview

110 Tumba Peak Small



TG0004G001
Frame: Matt black
Lens: Smoke. Cat 3



TG0004G002
Frame: Matt black
Lens: Brown with bronze multi. Cat 3



TG0004G003
Frame: Matt white
Lens: Purple with pink multi. Cat 2



TG0004G004
Frame: Matt Burgundy
Lens: Brown with pink multi. Cat 3



TG0004G005
Frame: Matt camo green
Lens: Smoke lens. Cat 3

1°23'S 29°36'E

111 Indira Col Maglink

Life & Globe

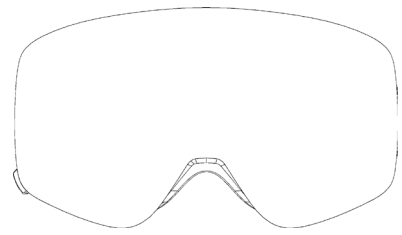

Description

The 111 Indira Col Maglink is a pair of large ski goggles that redefine convenience. With a broad field of view and an innovative maglink system you can easily switch lenses with the magnetic attachment. An additional contrast lens is included for use in challenging weather conditions.

The ventilated frame, equipped with three layers of foam, ensures a comfortable fit against the face. With a silicone strap for optimal helmet friction, a ventilated frame, and a sealed double lens featuring anti-fog treatment, these goggles are designed for peak performance.

Boasting an OTG (Over the Glasses) prepared design and a double buckle size adjustment, the 111 Indira Col Maglink combines functionality with versatility, setting

the standard for your skiing experience.

Keep your goggles in top condition: the storage pouch is specially designed to also act as a cleaning wipe, for permanent visual comfort.

Keep your goggles in top condition: the goggle sock is specially designed to also act as a cleaning wipe, for permanent visual comfort.

Standards

This model complies with international standards relating to eye protection for skiing and similar activities such as snowboarding (NF EN 174).

Technical Features

Maglink - Interchangeable lens system

Introducing Maglink, our revolutionary lens system that redefines simplicity in lens replacement with its innovative magnetic attachment. Experience the ease of changing lenses effortlessly, thanks to the straight-forward magnetic connection. This user-friendly system allows you to adapt to varying light conditions quickly and efficiently, ensuring optimal visibility and clarity on the slopes.

Built in anti-fog shield

The goggles are by nature anti-fog resistant and prevent condensation thanks to their sealed dual-material lens (polycarbonate on the outside and acetate on the inside).

Double buckle size adjustment

The goggles are equipped with a double buckle size adjustment to ensure optimum support and easy adjustment that last.

Tri-Field Vision

The wrap-around frame provides a wide field of view and enhanced peripheral vision to ensure optimal reflexes and improve your sports performance.

100% UV400 Protection

Our lenses block all harmful UVA, UVB & UVC light rays with wavelengths up to 400 nanometers – regardless of sun or cloud conditions.

OTG-prepared

This style has a cut out in the frame and can be worn over corrective glasses

L Fits Large Faces

Overview

111 Indira Col Maglink



TG0005G001

Frame: Matt black

Lens: Smoke. Cat 3

Extra lens: Purple/pink multi. Cat 1

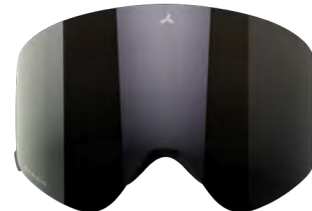

S Fits Small Faces

Overview

112 Indira Col Maglink Junior



TG0006G001

Frame: Matt black

Lens: Smoke. Cat 3

Extra lens: Purple/pink multi. Cat 1



1°23'S 29°36'E

113 Mount Roraima

Life & Globe

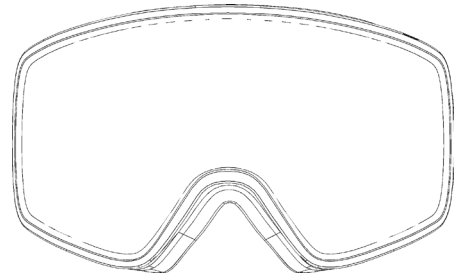

Description

Get to know the 113 Mount Roraima, a blend of sleek design and expansive vision for your skiing adventures. These large ski goggles feature clean lines and a wide field of view, ensuring you catch every moment on the slopes with clarity.

The ventilated frame, equipped with three layers of foam, provides comfortable contact with your face, while the silicone strap ensures secure friction against your helmet. The ventilated frame and sealed double lens with anti-fog treatment enhance visibility in varying conditions.

With an interchangeable lens, OTG preparedness, and a double buckle size adjustment, the 113 Mount Roraima is designed for versatility, comfort, and peak performance on the mountain.

Keep your goggles in top condition: the storage pouch is specially designed to also act as a cleaning wipe, for permanent visual comfort.

Standards

This model complies with international standards relating to eye protection for skiing and similar activities such as snowboarding (NF EN 174).

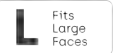

Technical Features

Built in anti-fog shield

The goggles are by nature anti-fog resistant and prevent condensation thanks to their sealed dual-material lens (polycarbonate on the outside and acetate on the inside).

Double buckle size adjustment

The goggles are equipped with a double buckle size adjustment to ensure optimum support and easy adjustment that last.

Tri-Field Vision

The wrap-around frame provides a wide field of view and enhanced peripheral vision to ensure optimal reflexes and improve your sports performance.

100% UV400 Protection

Our lenses block all harmful UVA, UVB & UVC light rays with wavelengths up to 400 nanometers – regardless of sun or cloud conditions.

OTG-prepared

This style has a cut out in the frame and can be worn over corrective glasses

Interchangeable lens

The weather conditions can suddenly change, then it might be handy to have a spare lens ready. On this frame, you can easily change from one lens to a lens that is best suited for the moment. Spare lenses are available for purchase.

Overview

113 Mount Roraima



TG0001G001
Frame: Matt black
Lens: Brown/blue multi. Cat 3



TG0001G002
Frame: Matt black
Lens: Purple/pink multi. Cat 3



TG0001G003
Frame: Matt black
Lens: Brown/silver mirror. Cat 3



TG0001G004
Frame: Matt camo green
Lens: Brown/silver mirror. Cat 3



TG0001G006
Frame: Matt pink
Lens: Pink/silver mirror. Cat 3



TG0001G007
Frame: Matt black
Lens: Yellow. Cat 1



TG0001G008
Frame: Matt black
Lens: Clear. Cat 0



TG0001G009
Frame: Matt black
Lens: Purple. Cat 1

1°23'S 29°36'E

114 Mount Roraima

Life & Globe

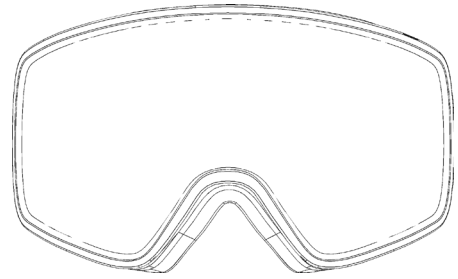

Description

Get to know the kids version of 113 Mount Roraima, a blend of sleek design and expansive vision for your skiing adventures. These large ski goggles feature clean lines and a wide field of view, ensuring you catch every moment on the slopes with clarity.

The ventilated frame, equipped with three layers of foam, provides comfortable contact with your face, while the silicone strap ensures secure friction against your helmet. The ventilated frame and sealed double lens with anti-fog treatment enhance visibility in varying conditions.

With an interchangeable lens, OTG preparedness, and a double buckle size adjustment, the 114 Mount Roraima is designed for versatility, comfort, and peak performance on the mountain.

Keep your goggles in top condition: the storage pouch is specially designed to also act as a cleaning wipe, for permanent visual comfort.

Standards

This model complies with international standards relating to eye protection for skiing and similar activities such as snowboarding (NF EN 174).

XS Fits Kids Faces

Technical Features

Built in anti-fog shield

The goggles are by nature anti-fog resistant and prevent condensation thanks to their sealed dual-material lens (polycarbonate on the outside and acetate on the inside).

Double buckle size adjustment

The goggles are equipped with a double buckle size adjustment to ensure optimum support and easy adjustment that last.

Tri-Field Vision

The wrap-around frame provides a wide field of view and enhanced peripheral vision to ensure optimal reflexes and improve your sports performance.

100% UV400 Protection

Our lenses block all harmful UVA, UVB & UVC light rays with wavelengths up to 400 nanometers – regardless of sun or cloud conditions.

OTG-prepared

This style has a cut out in the frame and can be worn over corrective glasses

Interchangeable lens

The weather conditions can suddenly change, then it might be handy to have a spare lens ready. On this frame, you can easily change from one lens to a lens that is best suited for the moment. Spare lenses are available for purchase.

Overview

114 Mount Roraima Kids



TG0002G001
Frame: Matt black
Lens: Brown/blue multi. Cat 3



TG0002G002
Frame: Matt white
Lens: Purple/pink multi. Cat 3



TG0002G003
Frame: Matt black
Lens: Brown/silver mirror. Cat 3



TG0002G004
Frame: Matt camo green
Lens: Brown/silver mirror. Cat 3



TG0002G006
Frame: Matt pink
Lens: Pink/silver mirror. Cat 3



TG0001G007
Frame: Matt black
Lens: Yellow. Cat 1



TG0001G008
Frame: Matt black
Lens: Clear. Cat 0



TG0001G009
Frame: Matt black
Lens: Purple. Cat 1

22°25'17"S 31°18'32"E

106 Frontier & 107 Frontier Junior

Life & Globe

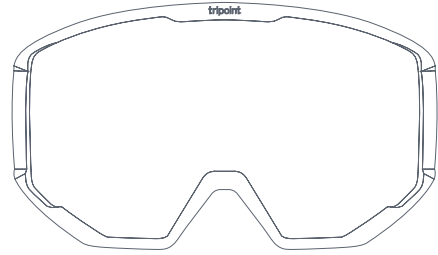

Description

Introducing the 106 Frontier Snow Goggle – the ultimate blend of comfort, protection, and practicality, all at a fair price. With this goggle, you'll experience the level of comfort you deserve while enjoying unparalleled vision on the slopes.

Designed with your utmost comfort in mind, the 106 Frontier features two layers of soft and cozy foam that conform seamlessly to the contours of your face. This ensures a snug and secure fit, allowing you to focus on the thrill of your winter adventures. The adjustable strap provides additional stability by securely fastening the goggles to your helmet, guaranteeing a safe and comfortable ride down the slopes.

106 Frontier is OTG-prepared and can be worn over corrective glasses and fits most of the helmets on the market.

Standards

This model complies with international standards relating to eye protection for skiing and similar activities such as snowboarding (NF EN 174).

Technical Features

Double buckle size adjustment

The goggles are equipped with a double buckle size adjustment to ensure optimum support and easy adjustment that last.

Tri-Field Vision

The wrap-around frame provides a wide field of view and enhanced peripheral vision to ensure optimal reflexes and improve your sports performance.

100% UV400 Protection

Our lenses block all harmful UVA, UVB & UVC light rays with wavelengths up to 400 nanometers – regardless of sun or cloud conditions.

OTG-prepared

This style has a cut out in the frame and can be worn over corrective glasses

M Fits
Medium
Faces

Overview

106 Frontier



TRIG106-BL-102S
Frame: Matt black
Lens: Amber single lens. Cat 2



TRIG106-WH-201S
Frame: Matt white
Lens: Purple single lens. Cat 1

S Fits
Small
Faces

Overview

107 Frontier Junior



TRIG107-BL-102S
Frame: Matt black
Lens: Amber single lens. Cat 2



TRIG107-WH-201S
Frame: Matt white
Lens: Purple single lens. Cat 1

22°25'17"S 31°18'32"E

108 Limpopo kids

Life & Globe

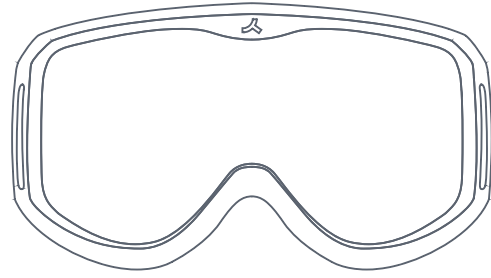

Description

Our kids just want to have fun. With snow goggle 105 Limpopo, the kids can focus on all the fun stuff. Like the next jump, the next turn or an upcoming snowball fight. Don't worry about all the boring stuff like; comfort, vision and safety, 105 Limpopo will handle that.

Comfort, protection and practicality guaranteed: The soft and comfortable 2-layers of foam will perfectly fit the contours of your kids face, while the adjustable strap hold on to the helmet to ensure a safe and comfortable ride down the slopes.

The lens is anti-fog treated to ensure your visual comfort and clarity.

105 Limpopo is OTG-prepared and can be worn over

corrective glasses and fits most of the helmets on the market.

Keep the goggles in top condition: the storage pouch is specially designed to also act as a cleaning wipe, for permanent visual comfort.

Standards

This model complies with international standards relating to eye protection for skiing and similar activities such as snowboarding (NF EN 174).

Technical Features

Double buckle size adjustment

The goggles are equipped with a double buckle size adjustment to ensure optimum support and easy adjustment that last.

Tri-Field Vision

The wrap-around frame provides a wide field of view and enhanced peripheral vision to ensure optimal reflexes and improve your sports performance.

100% UV400 Protection

Our lenses block all harmful UVA, UVB & UVC light rays with wavelengths up to 400 nanometers – regardless of sun or cloud conditions.

OTG-prepared

This style has a cut out in the frame and can be worn over corrective glasses

XS Fits Kids Faces

Overview

108 Limpopo kids



TRIG108-YL-802S

Frame: Matt yellow winter
Lens: Amber single lens. Cat 2



TRIG108-BE-802S

Frame: Matt blue winter
Lens: Amber single lens. Cat 2



TRIG108-PN-701S

Frame: Matt pink winter
Lens: Pink single lens. Cat 1

WHY TRIPPOINT SKI HELMETS?



Selecting a Tripoint Ski Helmet isn't just a choice; it's a commitment to your safety, comfort, and performance on the slopes. Here's why choosing a Tripoint Ski Helmet is a wise decision:

Safety First: Tripoint Ski Helmets are engineered with cutting-edge technology to provide maximum protection. They meet or exceed safety standards, ensuring your head is safeguarded in the event of a fall or collision. Your well-being is our top priority.

Comfortable Fit: Tripoint Ski Helmets are designed for a snug, comfortable fit. They come with adjustable straps and sizing options to ensure your helmet fits securely, eliminating distractions while you conquer the mountain.

Ventilation: Tripoint Helmets feature advanced ventilation systems to regulate temperature and prevent overheating. Stay cool and focused during intense runs while maintaining optimal warmth in colder conditions.

Durability: Crafted from high-quality materials, Tripoint Ski Helmets are built to withstand the rigors of skiing and snowboarding. They're designed to last season after season, providing excellent value for your investment.

Trusted by world-class athletes: Join the ranks of elite competitors who choose Tripoint for precision, durability, and unrivaled performance. When the best athletes in the world trust Tripoint, you know you're in good company.

Lightweight Design: We understand the importance of agility on the slopes. Tripoint Helmets are lightweight, so you won't feel weighed down, allowing you to tackle challenging terrain with ease.

Style and Versatility: Tripoint Helmets come in a variety of stylish designs and colors to suit your personal taste. Express your individuality while staying safe and comfortable on the slopes.

22°25'17"S 31°18'32"E

206 Tromeja

Tech & Soul



Description

Make the smart choice for your safety and performance on the slopes. Elevate your skiing experience with the 206 Tromeja Alpine Ski Helmet – where FIS certification meets the strength of full carbon shell construction. Get ready to conquer the mountain with confidence!

FIS Certified for Pro-Level Performance: Elevate your skiing game to the highest level with the 206 Tromeja helmet, proudly FIS certified. Trusted by professional athletes, it meets the stringent safety standards of the International Ski Federation, ensuring you're geared up for peak performance and protection.

Full Carbon Shell for Uncompromising Strength: Our helmet features a cutting-edge full carbon shell construction. This not only makes it incredibly lightweight but also exceptionally strong. You'll feel the difference as you confidently conquer challenging terrain.

Mips

Safety is our top priority, which is why we have incorporated MIPS (Multi-directional Impact Protection System) technology into the design of the 201 Trdkova. MIPS is a revolutionary system that helps reduce rotational forces during impacts, minimizing the risk of brain injuries. With MIPS, you can have peace of mind knowing that you're equipped with the latest in helmet safety technology.

Standard EN1077

Rest assured, the 206 Tromeja Race Helmet with MIPS complies with international safety standards, providing you with the utmost confidence in your gear. It is meticulously engineered to meet the highest industry standards for impact protection, ensuring that you're well-prepared for any unforeseen circumstances on the mountain.



Overview

206 Tromeja



Matt black
TRIH206-BL-S 50-53 cm
TRIH206-BL-SM 54-56 cm
TRIH206-BL-M 56-58 cm

22°25'17"S 31°18'32"E

208 Trdkova Slalom

Life & Globe



Description

208 Trdkova Slalom Helmet - a perfect blend of durability, comfort, and advanced features for alpine enthusiasts. Crafted with a hard shell ABS outer and an inner core of EPS, this helmet ensures robust protection. The MIPS system adds an extra layer of safety by reducing rotational forces during impacts. The retention system allows for a perfect fit, ensuring a secure and comfortable feel.

Slalom

Designed for Alpine slalom, the helmet comes with an adjustable chin guard, providing enhanced protection. The chin guard can be easily moved up and down to suit your preferences and is detachable if needed. Its aerodynamic design is optimized for high-speed performance, while the ventilation system keeps you cool during intense runs. The 208 Trdkova Slalom Helmet is your trusted companion for conquering the slopes with confidence and style.

Mips

Safety is our top priority, which is why we have incorporated MIPS (Multi-directional Impact Protection System) technology into the design of the 208 Trdkova Slalom. MIPS is a revolutionary system that helps reduce rotational forces during impacts, minimizing the risk of brain injuries. With MIPS, you can have peace of mind knowing that you're equipped with the latest in helmet safety technology.

Standard EN1077

Rest assured, the 208 Trdkova Slalom Helmet with MIPS complies with international safety standards, providing you with the utmost confidence in your gear. It is meticulously engineered to meet the highest industry standards for impact protection, ensuring that you're well-prepared for any unforeseen circumstances on the mountain.



Overview

208 Trdkova Slalom



Matt black

TH0002H001-S 50-54 cm

TH0002H001-M 54-58 cm

TH0002H001-L 58-61 cm



22°25'17"S 31°18'32"E

207 Trdkova Hardshell

Life & Globe

Mips

Description

The 208 Trdkova Hardshell Helmet, a pinnacle of safety and comfort for your alpine adventures. Constructed with a hard shell ABS outer and an inner core of EPS, this helmet provides unparalleled durability. The MIPS system enhances safety by reducing rotational forces during impacts, ensuring optimal protection.

Designed for a perfect fit, the helmet features a retention system that offers both security and comfort. Its aerodynamic design is tailored for high-speed performance, making it an ideal choice for enthusiasts who crave speed and precision. The ventilation system keeps you cool and comfortable, even during intense runs.

Mips

Safety is our top priority, which is why we have incorporated MIPS (Multi-directional Impact Protection System)

technology into the design of the 207 Trdkova Hardshell. MIPS is a revolutionary system that helps reduce rotational forces during impacts, minimizing the risk of brain injuries. With MIPS, you can have peace of mind knowing that you're equipped with the latest in helmet safety technology.

Standard EN1077

Rest assured, the 207 Trdkova Hardshell Helmet with MIPS complies with international safety standards, providing you with the utmost confidence in your gear. It is meticulously engineered to meet the highest industry standards for impact protection, ensuring that you're well-prepared for any unforeseen circumstances on the mountain.



Overview

207 Trdkova Hardshell



Mips

Matt black
TH0001H001-S 50-54 cm
TH0001H001-M 54-58 cm
TH0001H001-L 58-61 cm



Mips

Matt white
TH0001H002-S 50-54 cm
TH0001H002-M 54-58 cm
TH0001H002-L 58-61 cm



Mips

Matt Burgundy
TH0001H003-S 50-54 cm
TH0001H003-M 54-58 cm
TH0001H003-L 58-61 cm



Mips

Matt Dark Camo Green
TH0001H004-S 50-54 cm
TH0001H004-M 54-58 cm
TH0001H004-L 58-61 cm

22°25'17"S 31°18'32"E

201/202 Trdkova In-mold



Life & Globe

Description

Unleash your full potential on the slopes with the 201 Trdkova Free Ride Helmet. With its state-of-the-art MIPS technology, lightweight construction, customizable fit, and stylish design, this helmet is your ideal companion for thrilling adventures while prioritizing your safety and comfort. Experience the freedom of riding with confidence, knowing that you're protected by the best in the industry.

In-mold

Crafted using the innovative in-mold construction method, the 201 Trdkova is both lightweight and incredibly durable. By fusing the protective outer shell directly to the shock-absorbing EPS foam liner, we have created a helmet that offers superior impact resistance without compromising on comfort. You'll be able to ride with confidence, knowing that your head is well-protected.

Mips

Safety is our top priority, which is why we have incorporated MIPS (Multi-directional Impact Protection System) technology into the design of the 201 Trdkova. MIPS is a revolutionary system that helps reduce rotational forces during impacts, minimizing the risk of brain injuries. With MIPS, you can have peace of mind knowing that you're equipped with the latest in helmet safety technology.

Standard EN1077

Rest assured, the 201 Trdkova Free Ride Helmet with MIPS complies with international safety standards, providing you with the utmost confidence in your gear. It is meticulously engineered to meet the highest industry standards for impact protection, ensuring that you're well-prepared for any unforeseen circumstances on the mountain.



Overview

201/202 Trdkova MIPS



Matt black
TRIH202-BL-SM 52-54 cm
TRIH202-BL-M 54-58 cm
TRIH202-BL-L 58-61 cm



Matt white
TRIH202-WH-SM 52-54 cm
TRIH202-WH-M 54-58 cm
TRIH202-WH-L 58-61 cm



Matt Ruby Pink
TRIH202-PI-SM 52-54 cm
TRIH202-PI-M 54-58 cm
TRIH202-PI-L 58-61 cm



Matt Forest Green
TRIH202-GN-SM 52-54 cm
TRIH202-GN-M 54-58 cm
TRIH202-GN-L 58-61 cm



Matt black
TRIH201-BL-SM 52-54 cm
TRIH201-BL-M 54-58 cm
TRIH201-BL-L 58-61 cm



Matt white
TRIH201-WH-SM 52-54 cm
TRIH201-WH-M 54-58 cm
TRIH201-WH-L 58-61 cm



Matt Ruby Pink
TRIH201-PI-SM 52-54 cm
TRIH201-PI-M 54-58 cm
TRIH201-PI-L 58-61 cm



Matt Forest Green
TRIH201-GN-SM 52-54 cm
TRIH201-GN-M 54-58 cm
TRIH201-GN-L 58-61 cm

22°25'17"S 31°18'32"E

203/204 Constance Kids In-mold

Life & Globe

Mips

Description

Introducing the 203 Constance Kids Free Ride Helmet—a top-of-the-line helmet designed specifically to provide young riders with exceptional safety and comfort during their winter adventures. Available in two versions—one with MIPS technology and another without—you can choose the level of advanced protection that suits your child's needs.

In-mold

Crafted with the innovative in-mold construction method, the 203 Constance is both lightweight and durable. By fusing the protective outer shell directly to the shock-absorbing EPS foam liner, we have created a helmet that offers excellent impact resistance while keeping weight to a minimum. This allows young riders to comfortably explore the slopes without feeling weighed down.

Mips (Optional)

Safety is our top priority, which is why we have incorporated MIPS (Multi-directional Impact Protection System) technology into the design of the 203 Trdkova. MIPS is a revolutionary system that helps reduce rotational forces during impacts, minimizing the risk of brain injuries. With MIPS, you can have peace of mind knowing that you're equipped with the latest in helmet safety technology.

Standard EN1077

Rest assured, the 203 Constance Kids Free Ride Helmet complies with international safety standards, guaranteeing the utmost protection for your child. It is meticulously engineered to meet the highest industry standards for impact protection, ensuring your young rider's safety on the slopes.



Overview

203/204 Constance



Matt black
TRIH203-BL-XS 48-52 cm



Matt Sunshine Yellow
TRIH203-YL-XS 48-52 cm



Matt Raspberry Pink
TRIH203-PI-XS 48-52 cm



Matt Grass Green
TRIH203-GR-XS 48-52 cm



Matt black
TRIH204-BL-XS 48-52 cm



Matt Sunshine Yellow
TRIH204-YL-XS 48-52 cm



Matt Raspberry Pink
TRIH204-PI-XS 48-52 cm



Matt Grass Green
TRIH204-GR-XS 48-52 cm

22°25'17"S 31°18'32"E

205 Rodange

Life & Globe



Description

Ready to conquer the mountain like a pro? Elevate your skiing experience with the 205 Rodange Alpine Ski Helmet – where FIS certification meets the durability of an ABS shell, with the added option to optimize your slalom performance. Get ready to race with confidence and style!

FIS Certified for Elite Performance: Elevate your skiing to a professional level with the 205 Rodange helmet, proudly certified by the International Ski Federation (FIS). It meets the rigorous safety standards set by the pros, guaranteeing you top-tier performance and protection.

Durable ABS Shell: Our helmet boasts an ultra-durable ABS shell, designed to withstand the toughest challenges on the mountain. Whether you're carving down steep slopes or tackling slalom gates, the 205 Rodange delivers uncompromising strength and impact resistance.

Customizable for Slalom: For slalom enthusiasts, we offer the unique advantage of adding a compatible chin guard.

This feature transforms your helmet into a specialized slalom racing powerhouse, giving you the edge you need to shave those crucial seconds off your time.

Tailored Fit for Precision: Our helmet offers a customizable fit system, ensuring a secure, personalized fit. This eliminates distractions and allows you to focus entirely on the precision and control needed for exceptional skiing.

Standard EN1077

Rest assured, the 205 Rodange Race Helmet complies with international safety standards, providing you with the utmost confidence in your gear. It is meticulously engineered to meet the highest industry standards for impact protection, ensuring that you're well-prepared for any unforeseen circumstances on the mountain.





Matt black
TRIH205-BL-S 51-52 cm
TRIH205-BL-SM 51-54 cm
TRIH205-BL-M 55-59 cm

Chin Guard - One Size
TRIHS205-BL-CG



Senior Helmet & Goggle package

Trdkova Ski Helmet

Construction: Hardshell
Color: Black

Tumba Peak Ski Goggle

Frame: Black
Lens: Brown/mirror cat 2

Senior Black Small
Senior Black Medium
Senior Black Large



Trdkova Ski Helmet

Construction: Hardshell
Color: White

Tumba Peak Ski Goggle

Frame: Black
Lens: Brown/mirror cat 2

Senior White Small
Senior White Medium



Junior Helmet & Goggle package

Constance Ski Helmet XS

Construction: Hardshell
Color: White

Mount Roraima Ski Goggle Junior

Frame: Black
Lens: Amber cat 2

Junior XS
Junior S



Merch



TRIM4-WH-OZ
Cap



TRIM5-WH-OZ
Mango soda

Tee
TRIM3-WH-XS
TRIM3-WH-S
TRIM3-WH-M
TRIM3-WH-L
TRIM3-WH-XL



Bag
TRIM2-WH-OZ



Hat
TRIM1-WH-OZ



Displays



Wooden small sign Tripoint Logo



Wooden Desk display



Wooden floor combi

Tripoint Combi Floor



Goggles



Helmets



